

BRIGHT

Erasmus+ strategic partnership for Higher Education

BOOSTING THE SCIENTIFIC EXCELLENCE AND INNOVATION
CAPACITY OF 3D PRINTING METHODS IN PANDEMIC PERIOD

MODULE 7

Medical Engineering Standards and Tests

Project Title	Boosting the scientific excellence and innovation capacity of 3D printing methods in pandemic period 2020-1-RO01-KA226-HE-095517
Output	O1 - BRIGHT e-learning support courses for curriculum aiming to boost the scientific excellence and innovation of 3D printing methods used for developing and producing medical parts in pandemic period
Module	Module 7 Medical Engineering Standards and Tests
Date of Delivery	July 2021
Authors	Sven MARIČIĆ Razvan PĂCURAR Ivan VELJOVIĆ, Matea GRDIĆ Ivona PETERNEL

	<p>Kristina HLAVATI BERTONCELJ Miloš SIMONVIĆ Nikola VITKOVIĆ Mate BABIĆ</p>
<p>Version</p>	<p>Final Version</p>

This project has been funded with support from the European Commission. This publication [communication] reflects the views only of the authors, and the Commission cannot be held responsible for any use which may be made of the information contained therein.

Contents

1.	Introduction.....	1
1.1	Medical Engineering Standards.....	1
1.2	Application of artificial intelligence.....	1
1.3	Machine learning.....	3
1.4	Chatbot application.....	4
1.5	CAD/CAM.....	5
1.6	Additive technologies - print of protective face shields.....	7
1.6.1	Face shield PRUSA PRO.....	8
1.6.2	3D Verkstan.....	10
1.6.3	Operation Ppe.....	11
1.6.4	Maker Mask.....	11
1.6.5	combineLA.....	12
1.6.6	Maker Works.....	13
2	CAD solutions for medical purposes, software overview.....	16
2.1	InVesalius.....	16
2.2	ITKSnap.....	17
2.3	3D Slicer.....	18
2.4	Ginkgo CADx.....	19
3	Testing and controlling.....	23
3.1	Standardisation process.....	23
3.2	Standards and tolerances, dimension control.....	23
4	Measurements.....	30
4.1	Geometrical metrology.....	30
4.2	CAD metrology.....	30

This project has been funded with support from the European Commission. This publication [communication] reflects the views only of the authors, and the Commission cannot be held responsible for any use which may be made of the information contained therein.

4.3	CMM - coordinate measuring machine.....	34
4.4	3D scanning	36
4.5	Photogrammetry	37
4.5.1	Medical Applications of Photogrammetry.....	38
4.6	Dimension control - with Artificial Intelligence.....	39
5	Preparation for testing in the clinical environment	41
5.1	Implementation of Artificial Intelligence	41
5.1.1	Key implementation issues of AI in medical field	42
6	Virtual reality laboratory as a testing platform	46
7	The Ethical guidance for medical simulation and devices.....	48
7.1	Medical Simulation.....	48
6.	References	53

This project has been funded with support from the European Commission. This publication [communication] reflects the views only of the authors, and the Commission cannot be held responsible for any use which may be made of the information contained therein.



B. M. PLAST d.o.o.

1. Introduction

1.1 Medical Engineering Standards

1.2 Application of artificial intelligence

Various technologies are enacted and experimented with to increase automation in the field of medicine. Artificial intelligence (AI) is being introduced in the field of medicine to make medical records in digital form and patient behavior examinations using smart technologies. Artificial intelligence offers solutions, especially in targeted treatments, unique in the composition of drugs and personalized therapy. (Haleem, Javaid and Haleem Khan, 2019). One of the advantages of artificial intelligence is reducing documentation time by storing patient's data digitally and forming a digital database, which can further be used for diagnosis, treatment, and regular medicare (Haleem, Javaid and Haleem Khan, 2019). Artificial intelligence can solve different medical challenges, such as solving a different level of difficulty while performing complex surgeries with better quality and outcome (Haleem, Javaid and Haleem Khan, 2019). Figure 1. Shows some of the benefits of Artificial intelligence in the medical field.

This project has been funded with support from the European Commission. This publication [communication] reflects the views only of the authors, and the Commission cannot be held responsible for any use which may be made of the information contained therein.



B. M. PLAST d.o.o.

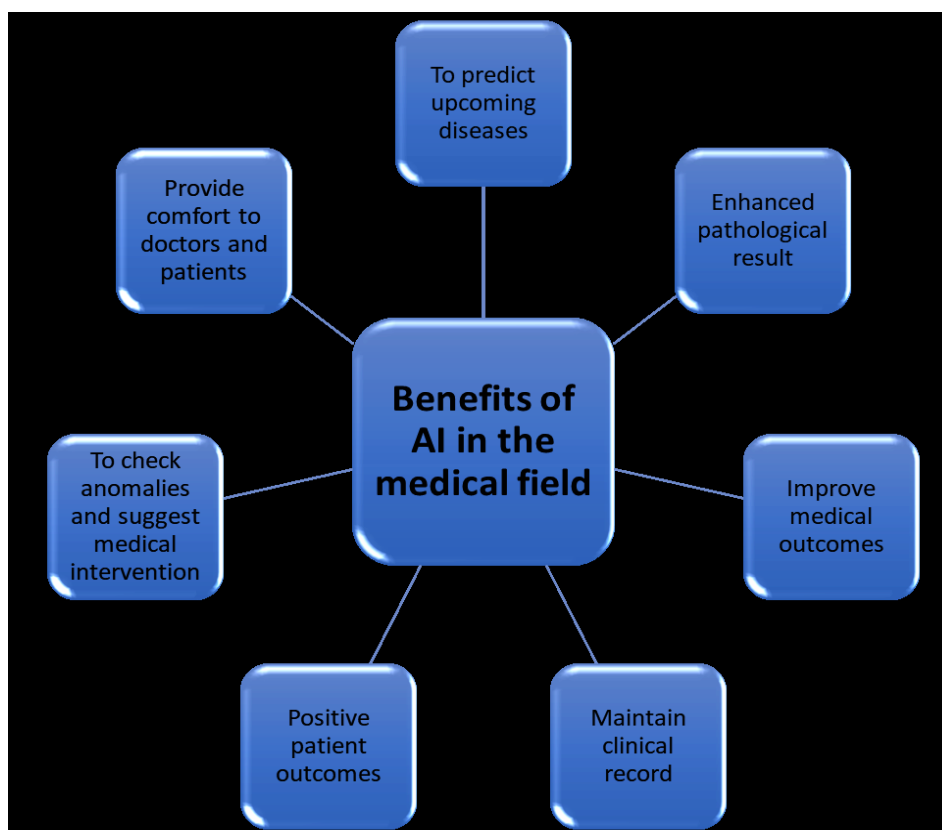

Figure 1. Benefits of AI in the medical field

Adapted from: Haleem, Javaid and Haleem Khan (2019)

AI provides numerous innovations in the medical field. It effectively analyzes information, medical records and systems and improves digital automation for faster and more consistent results. It helps doctors to achieve better results (Haleem, Javaid and Haleem Khan, 2019). Figure 2. shows the achievements of AI in the medical field.

Medicine	<ul style="list-style-type: none"> • Advancement in diagnosis, treatment personalisation and drug development • This technology is useful for clinical trials and useful for effective monitoring to achieve an accurate result.
Surgery	<ul style="list-style-type: none"> • Doctors and surgeons are efficiently integrating AI in surgery by capturing data of all phases. • Provides efficient results of complex surgery
Radiology	<ul style="list-style-type: none"> • AI-assisted surgery improves consistency and accuracy • Helps the surgeon to obtain better surgical and treatment results.
Hospital administration and medical records	<ul style="list-style-type: none"> • Helps track the vital statistics of the patients and provides real-time information to the doctor and to the family of the patients. • It is helpful for the proper verification of patient health systems, which effectively leads the hospital
Cardiology	<ul style="list-style-type: none"> • Reduce the risk of sudden cardiac death • Makes aware of the blockage in the heart valve to avoid the chances of a heart attack.

Figure 2. Advancement of AI

This project has been funded with support from the European Commission. This publication [communication] reflects the views only of the authors, and the Commission cannot be held responsible for any use which may be made of the information contained therein.

Adapted from: Haleem, Javaid and Haleem Khan (2019)

Figure 3. shows different types of artificial intelligence technologies in the medical field.

Machine learning (ML)	Artificial neural network (ANN)	Natural language processing (NLP)	Support vector machine (SVM)	Heuristics analysis (HA)
<ul style="list-style-type: none"> Machine learning systems are programs that are self-improving and learning without experience or have been trained over time In the field of medicine, this technology is used to identify the likelihood of disease 	<ul style="list-style-type: none"> Artificial neural network works and is inspired by the neural structure of the human brain, working on the concept of backpropagation and layers Helpful in forecasting the incidence of disease and in decision-making 	<ul style="list-style-type: none"> NLP refers to the speech recognition and evaluation of languages with different techniques In the medical field, this technology is useful for clinical decision trials and supports and analyses the unstructured data 	<ul style="list-style-type: none"> A support vector machine determines the class groups of data for the given input data Used for collection and processing of medical data 	<ul style="list-style-type: none"> This technique uses a trial and error method for detection and discovery to solve a problem Heuristic analysis is best to approach for patient safety and efficiently identify different problems

Figure 3. Different types of artificial intelligence technologies in the medical field

Adapted from: Haleem, Javaid and Haleem Khan (2019).

1.3 Machine learning

The use of machine learning techniques in healthcare predicts enormous contributions in control of rare diseases (Fernandes, Barbalho, Barros et al., 2021). Although the direct goal of biological modeling is to describe data, it ultimately aims to find ways to connect systems and strengthen understanding of the goals, algorithms, and mechanisms of the system. Machine learning is becoming easy to use and should be a crucial tool for a full range of biomedical issues to advance understanding the system (Kording, Benjamin, Farhoodi and Glaser, 2018). Machine learning creates algorithms that can learn from a large amount of data and forecast the data (Kohavi and Provost, 1998). Machine learning is applied over a broad range of computer tasks, such as optical character recognition, email filtering, computer vision and many more (Park, Took and Seong, 2018). Machine learning applies to a wide range of computer vision, including object detection and tracking, augmented reality, computer photography, image recognition, face detection, automatic document analysis and medical image processing (Park, Took and Seong, 2018). Machine learning in biomedical engineering attempts to encompass the range of different machine learning applications in the biomedical engineering field, with special emphasis on the most representative machine learning techniques, or a deep learning access. The tasks of machine learning are usually classified into two broad categories, depending on

This project has been funded with support from the European Commission. This publication [communication] reflects the views only of the authors, and the Commission cannot be held responsible for any use which may be made of the information contained therein.

whether there is a learning “mark” or “feedback” system: supervised learning and unsupervised learning. There are also two different types of machine learning in the field of biomedical engineering from clustering (unsupervised learning) and classification (supervised learning).

Below is listed several practical applications of medical image analysis (Iqbal, Ghani Khan, Saba and Rehman, 2018) :

- Radiotherapy
- Computer-guided surgery
- Locating an abnormal region and other pathologies
- Treatment planning
- Measuring tissue sizes
- Computer aided diagnosis
- Study of anatomical structure
- Identification of malignant parts within the tumor to reduce the risk of sampling error

Iqbal, Ghani Khan, Saba, and Rehman (2018). used digital image processing techniques for extraction to categorize and analyze brain tumors using magnetic resonance imaging (MRI). There are only a few works that report multi-grade classification brain images where each part of the image containing the tumor is marked with major and minor categories. Iqbal et al. (2018) claims that precise classification is difficult to achieve due to ambiguity in the images and overlapping characteristics of different types of tumors.

Lahmiri, Dawson and Shmuel (2017). evaluated the performance of machine learning based techniques for Parkinson’s disease (PD) diagnosed based on dysphonia symptoms. They considered several machine learning techniques to classify healthy and PD patients. These machine learning methods included linear discriminant analysis (LDA), naive Bayesian (NB), k nearest neighbors (k-NN), , regression trees (RT), radial basis function neural networks (RBFNN), vector support machine (SVM) , distance classifier Mahalanobis and radial basis function neural networks (RBFNN).

1.

1.4 Chatbot application

The development and training of a clever conversational agent have long been a human race goal and a massive task for scientists and programmers. It was all a dreaming possibility from the science-fiction novels until lately. However, cutting-edge technologies like deep learning and neural networks are giving language teachers fresh hope by equipping them with smart chatbots that can

This project has been funded with support from the European Commission. This publication [communication] reflects the views only of the authors, and the Commission cannot be held responsible for any use which may be made of the information contained therein.

learn via dialogue much like people. The availability of chatbots nowadays aids in the creation of a new instructional environment for foreign language learners (Dokukina, 2020). New technology allowed for the quick installation of numerous digitally based applications. One of these has been utilised in many functions, including customer service, technical assistance, education, and training (Smutny & Schreiberova, 2020). Chatbot programmes function like instant messaging and may engage with the user over a specified topic or area using text and/or voice. Because chatbots are effective digital assistants that can deliver information to their users, answer inquiries, and debate certain topics, they are very desirable tools (Deveci; Topal, 2021). Digital assistants can recognise a user's preferences, provide suggestions, and anticipate their needs (Oracle Turkey, 2014a). Most people are familiar with personal digital assistants such as Apple's Siri, Amazon's Alexa, Microsoft's Cortana, and Google's Assistant (Smutny & Schreiberova, 2020). There are chatbot apps that are text-based and speech-based. To respond to their users, most text-based chatbots employ rules and facts (Budiu, 2018). As the number of students assigned to each instructor grows, so does the amount of time allocated to each. Students who are unable to ask their instructor questions can obtain responses 24 hours a day, seven days a week by employing chatbots to supplement the teacher. The constructionist method enables the learner's use of chatbot interaction to manage their own learning at their own pace. Students are given the opportunity to talk and ask questions with one another (Singh, 2018).

1.5 CAD/CAM

Computer-aided design (CAD) is used to facilitate the modeling, simulation, engineering design, analysis, and production. Advances in medical imaging, computer graphics, and image processing have created new ways for CAD in the modeling, design, and development of many essential non-biomedical and biomedical applications (Mangrulkar, Rane and Sunnapwar, 2020). Non-medical use of CAD technologies is used in anthropology, forensic medicine, passenger safety product design and impact analysis. The biomedical use of CAD serves to develop implants, scaffolding, surgical guides, prostheses, and other medical devices (Mangrulkar, Rane and Sunnapwar, 2020). The application of CAD in medicine has been present since the 1950s (Wang and Yu, 2019). Lusted (1955). first introduced the mathematical model of CAD and presented it in medicine.

CAD can be used to create a three-dimensional (3D) bio model from primary medical imaging modalities. It includes computed tomography (C.T.) /micro-CT, Magnetic resonance imaging (MRI)/micro-MRI, Positron emission tomography (PET) and optical microscopy. The data derived from these modalities use a three-dimensional reconstruction of virtual biomedical models, which is further

This project has been funded with support from the European Commission. This publication [communication] reflects the views only of the authors, and the Commission cannot be held responsible for any use which may be made of the information contained therein.

useful for implant design, analysis and simulation, and fabrication shown in Figure 4. (Mangrulkar, Rane and Sunnapwar, 2020).

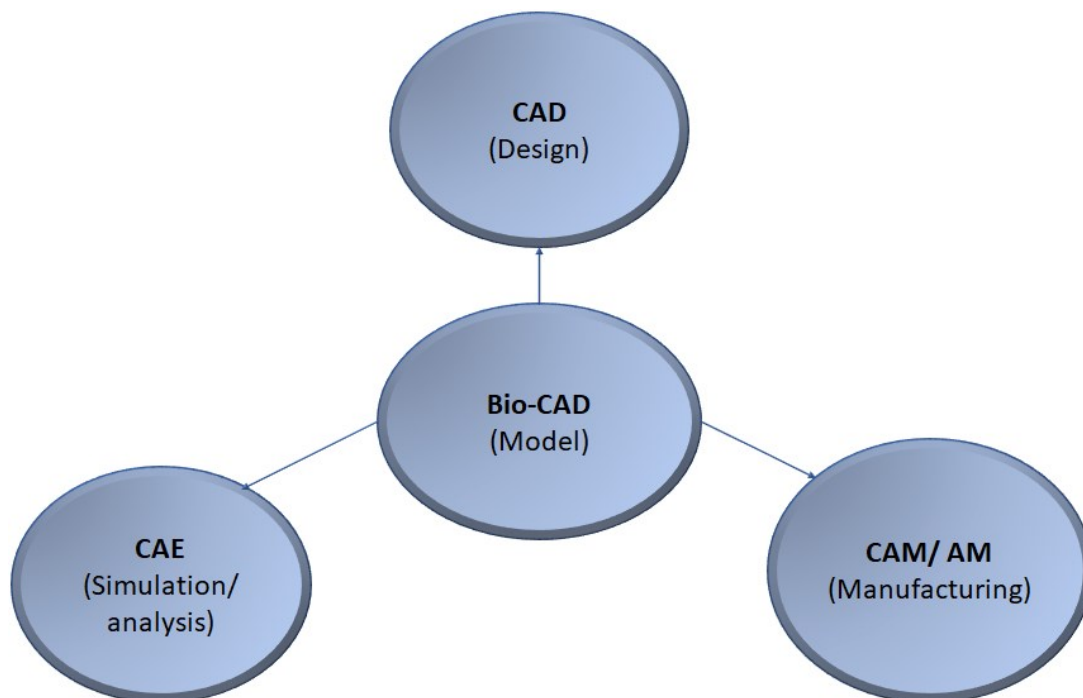

Figure 4. Bio-CAD model

Adapted from: Mangrulkar, Rane and Sunnapwar (2020).

Therefore, there is a need to research in constructing a virtual model to provide valuable medical information to the patient for good understanding anatomy functionality for disease diagnosis and treatment procedure. Ber primary imaging modalities will not allow physicians to quickly diagnose the disease and plan treatment. Modeling parts of the human body in a CAD-based environment, known as virtual Bio-CAD modeling. These reconstructed 3D models have medical as well as non-medical applications shown in Figure 5. (Mangrulkar, Rane and Sunnapwar, 2020).

This project has been funded with support from the European Commission. This publication [communication] reflects the views only of the authors, and the Commission cannot be held responsible for any use which may be made of the information contained therein.

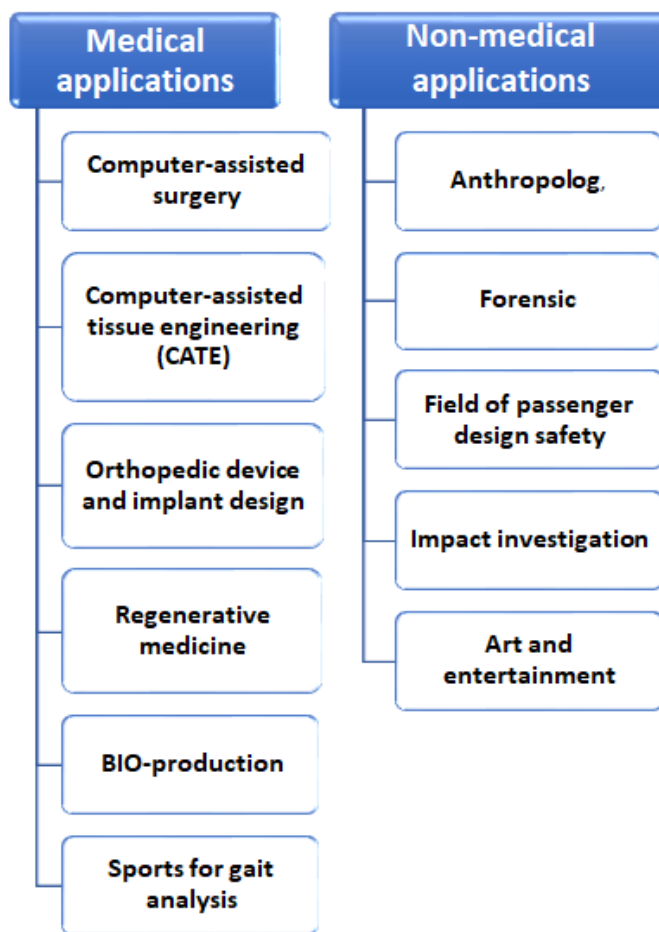

Figure 5. Medical and non-medical applications

Adapted from: Mangrulkar, Rane and Sunnapwar (2020).

1.6 Additive technologies - print of protective face shields

Severe acute respiratory syndrome coronavirus (SARS-CoV-2) transmitted by respiratory droplets and contact pathways, therefore increasing demand for personal protective equipment. Additive manufacturing proved to be ideal for the demand for personal protective equipment (Wierzbicki et al., 2020). Wierzbicki et al. (2020) investigated the possibilities of applying additive production technologies in the interventional production of protective masks for medical staff. They used AnEnder 3 Pro 3D printer to print headbands and Cura 4.4 was chosen as the slicing software. Open-source face shield designs were downloaded as standard tessellation language (STL) files and compared. Figure 6. shows a 3D printed protective face shield.

This project has been funded with support from the European Commission. This publication [communication] reflects the views only of the authors, and the Commission cannot be held responsible for any use which may be made of the information contained therein.



Figure 6. Prusa RC 3 protective face shield

From: Wierzbicki et al. (2020)

1.6.1 Face shield PRUSA PRO

During the coronavirus pandemic, these face shields became an important help not only to medical staff, but also to all those who have to communicate with many people. In response to an acute shortage of protective clothing for medical personnel in the current pandemic situation, Prusa Research developed rapidly and began mass-producing protective face shields. They printed and donated almost 200.000 shields to medics and other professionals in the Czech Republic (Prusa3D, 2021). Prusa Research is a 3D printing company based in Prague, Czech Republic.

The PRUSA PRO face shield is certified protective equipment against drops and liquid spray. It serves as an additional layer of protection in the environment with a higher risk of hitting the face with various liquids. The shield is certified in accordance with standard EN 166: 2001 1 S 3. The design of the face shields is completely open, anyone can produce and / or modify it. Also, the shields are made of easily accessible and inexpensive materials.

The visor is transparent (meets the standard of optical class 1), it is suitable for long-term work, even while wearing goggles (without fogging!), Respirators or other protective equipment. The shield also meets an increased standard of toughness (symbol "S"), the surface of the headband is smooth and comfortable (made by spraying) and is certified to be effective as protective equipment against drips and liquid spraying (Prusa 3D, 2021). The face shields consist of 4 parts. The assembly is very simple and takes only a few minutes.

This project has been funded with support from the European Commission. This publication [communication] reflects the views only of the authors, and the Commission cannot be held responsible for any use which may be made of the information contained therein.

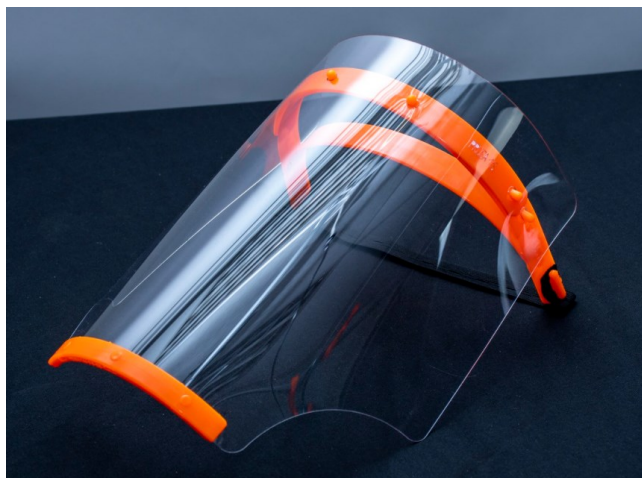

Figure 7. Prusa PRO

This project has been funded with support from the European Commission. This publication [communication] reflects the views only of the authors, and the Commission cannot be held responsible for any use which may be made of the information contained therein.

1.6.2 3D Verkstan

Due to the lack of personal protective equipment in Sweden, the 3D Verkstan decided to support the local target and produce protective shields for doctors and nurses. Own production and distribution of 3D-printed visors 3DVerkstan is committed to other relevant initiatives to enable more efficient distribution. Through this process 3DVerkstan has worked closely with various organizations and authorities, and the visor has been tested and approved in healthcare globally. Figure 8-9. shows 3d printed Protective Visor made by 3D Verkstan.

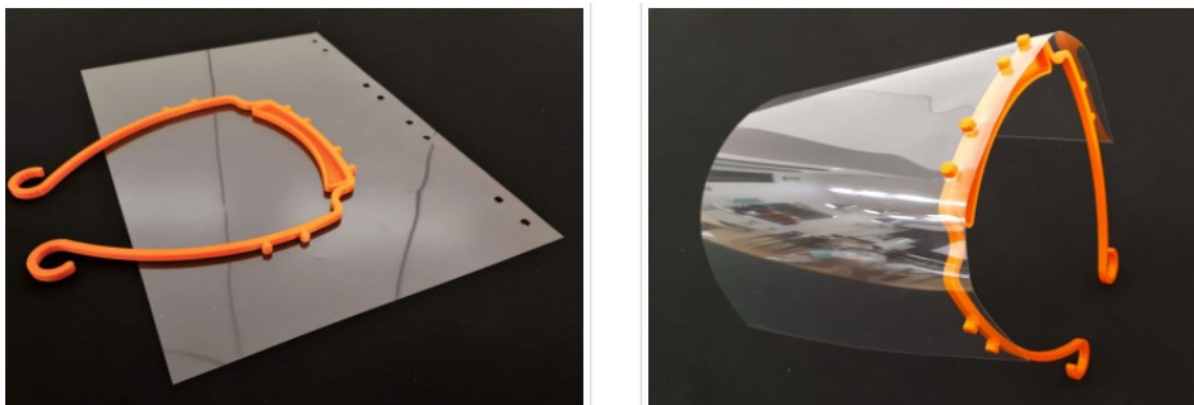

Figure 8-9. 3D-Printed Protective Visor (3D VERKSTAN)

Design goals include:

1. Using easily accessible plastic sheets with as few modifications as possible, and only the usual tools used.
2. Drip protection above the eyes
3. Design that works equally well with most common materials (PLA, CPE, PETG, ABS etc.)
4. All printing features with nozzle size up to 1 mm and layer height up to 0.5 mm
5. Printable in less than 20 minutes
6. No tight tolerances require well-tuned printers.

The frame is designed to be printed with a 0.8mm or larger nozzle and coarse layer heights (Figure 10).

This project has been funded with support from the European Commission. This publication [communication] reflects the views only of the authors, and the Commission cannot be held responsible for any use which may be made of the information contained therein.

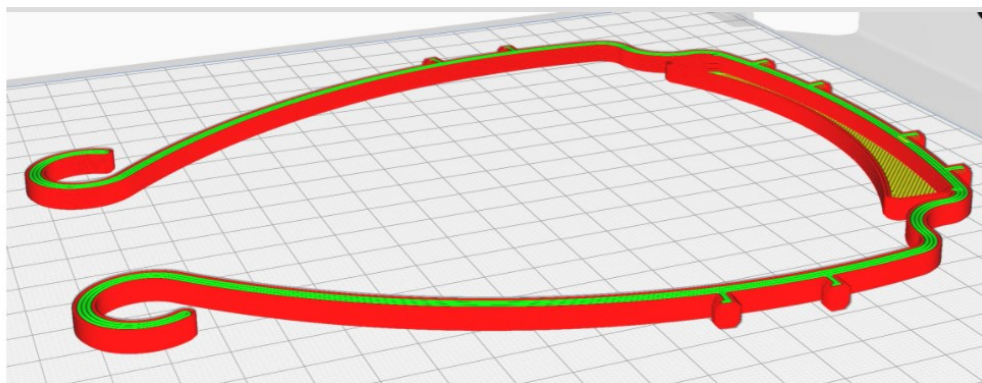

Figure 10. The frame of protective visor (3D VERKSTAN)

From: <https://3dverkstan.se/protective-visor/>

1.6.3 Operation Ppe

Cornell AAP and Sabin Lab work with Cornell Engineering, Cornell CIS, and many others across the community on 3D printing and laser-cut visors and face shields for nurses, doctors and healthcare professionals on the front lines.



Figure 11. Digitally manufactured visors and protective face shields

From: <https://www.sabinlab.com/operation-ppe>

1.6.4 Maker Mask

Tim iz Seattla stvorio je i objavio dizajn otvorenog koda za 3D tiskani respirator, nazvan Maker Mask (Figure 12.). The design is NIH approved for all community-based applications: This approval applies to use outside of direct health care and benefits critical primary service providers in the first

This project has been funded with support from the European Commission. This publication [communication] reflects the views only of the authors, and the Commission cannot be held responsible for any use which may be made of the information contained therein.

place. A Marker mask is a great option for basic service resources that provide our communities with food and other necessities. All parts are 3D printable within 1.5 Hours, and the HEPA filter is replaceable.

Features and Benefits of Maker Mask:

- Softer plastic for a more comfortable fit
- 3 uniformly sized filters
- Same filter quality, but with fewer pieces to print and assemble!
- Easier breathability



Figure 12. 3D printed respirator Maker Mask.

From: <https://www.makermask.com/>

1.6.5 combineLA

Thousands of emergency room staff and other healthcare workers across LA Country are being exposed to asymptomatic COVID-19 carriers every day. Many do not have adequate Personal Protective Equipment (PPE) to keep themselves or their patients safe. CombineLA is the production of PPE donated to local hospitals and health facilities.

CombineLA produces protective face masks using a mixture of 3D printing and laser cutting, with the aim of switching to injection molding. Figure 13. shows personal protective equipment made by CombineLa.

This project has been funded with support from the European Commission. This publication [communication] reflects the views only of the authors, and the Commission cannot be held responsible for any use which may be made of the information contained therein.

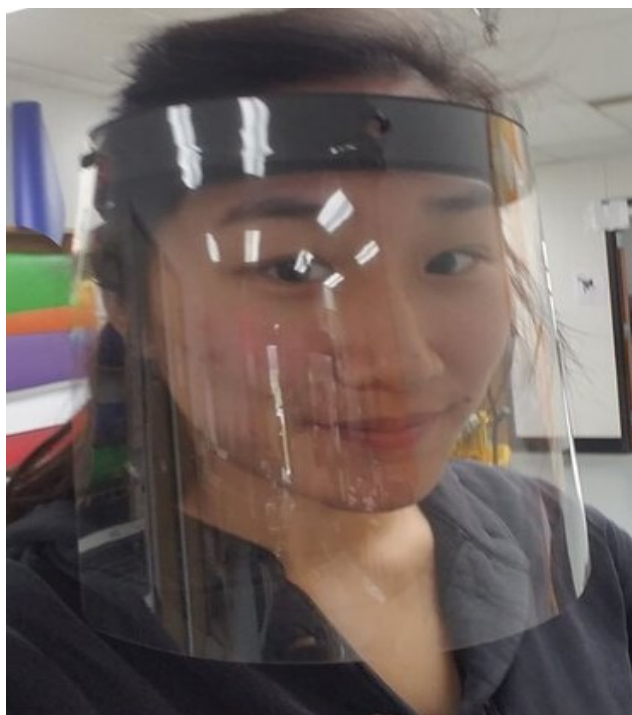

Figure 13. Personal Protective Equipment (PPE) by *combineLA*

From: <https://combine.la/>

1.6.6 Maker Works

Maker Works not only to produce, but also to collect and distribute protective equipment supplied by volunteers. Marker Works worked directly with the U of M hospital to design and fabricate UM-approved face shields and face mask adjusters (laser cut and CNC). These were donated to UM, St. Joe's, Beaumont hospitals and other health care facilities (Marker Works, 2020).



This project has been funded with support from the European Commission. This publication [communication] reflects the views only of the authors, and the Commission cannot be held responsible for any use which may be made of the information contained therein.

Figure 14. Face shields by Maker works

From: <https://www.maker-works.com/helping-in-the-covid-19-crisis#faceshields>

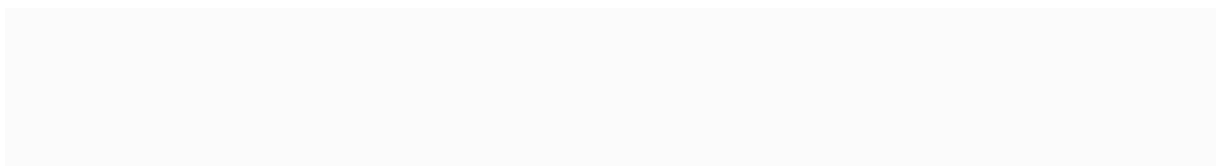

This project has been funded with support from the European Commission. This publication [communication] reflects the views only of the authors, and the Commission cannot be held responsible for any use which may be made of the information contained therein.

This project has been funded with support from the European Commission. This publication [communication] reflects the views only of the authors, and the Commission cannot be held responsible for any use which may be made of the information contained therein.



B. M. PLAST d.o.o.

2 CAD solutions for medical purposes, software overview

In this chapter several software solutions regarding biomedical imaging will be analysed and presented.

2.1 InVesalius

Official webpage(s):

<https://invesalius.github.io/about.html>

Description: InVesalius is a freeware to scan, rescan, and save magnetic and computed tomography (CT) files. It is used in the development of rapid prototyping, the teaching applications, digital pathology, and medical testing applications. This computer operating solution is designed on the Windows, GNU/Linux, and Mac OS X platforms. The most notable features of the software are the import of DIC or Analy, the possibility, the export of STL, OBO and PLY files, as well as the ability to render volumes or semi-automatic visualization of images.

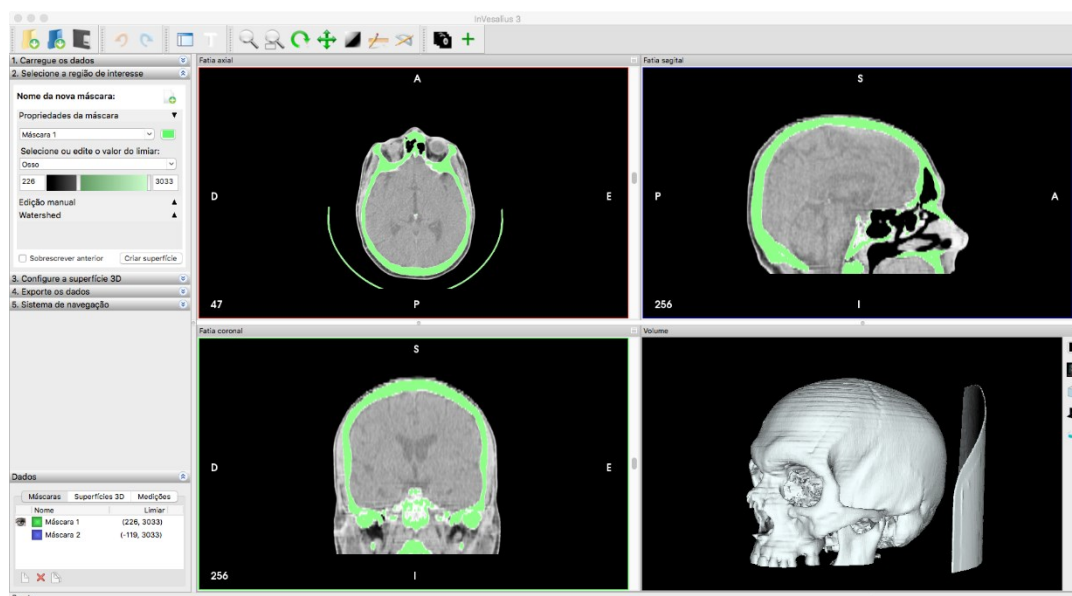

Figure 15. Working area and 3D skull model segmented
(InVesalius, 2021) Official webpages

InVesalius developed out of a need for more technologically advanced clinical trial resources when the CTI (Clinical Trial Institute of Inventories) started in Brazil in 2001. Hospitals and clinics at the time did not have a programming need wasable to match the medical imaging requirements in Brazil at the

This project has been funded with support from the European Commission. This publication [communication] reflects the views only of the authors, and the Commission cannot be held responsible for any use which may be made of the information contained therein.

time was not have a plan. they wanted to give society better overall direction to the development of the country by putting their plans on paper

Free of charge, at least to the buyer. Expanding since 2001. it is currently under constant revision to meet the needs of an analysis of the Brazilian Health Ministry, and to meet the needs following the analysis of thousands of users.

Citation(s): (InVesalius, 2021) Official webpages

2.2 *ITKSnap*

Official webpage(s):

<http://www.itksnap.org/pmwiki/pmwiki.php>

Description:

itk-SNAP is a software package to aid in the generation of 3D digital representations of medical anatomical structures The goals of the Penn Computing and Science Laboratory (PICSL) are to develop functions that will be simple and comprehensible to Paul Yushvich, a Ph.D., and to Utah-based Ph.D.D. Dr. Guido Gerig. ITAP is completely free, multi-platform, and open source.

A supplementary method of delineation which is semi-automatic and active contour detection is also has been available for some time now. ITAP will aid you in the creation of new applications as well as these basic capabilities. Some of the notable benefits of ITK-major SNAP's operation include:

- Seamless 3D navigation
- Manual segmentation at once in three orthogonal planes
- A modern user interface with Qt graphics
- Support for various 3D picture formats, including NifTI and DICOM
- Support for simultaneous, associated display and multi-image segmentation Color, multi-channel and time varying images support
- 3D cut-plan tool for fast segmentation results after processing
- Large documentation on tutorials and video

IT K-SNAP architecture focuses primarily on the issue of image segmentation compared to other, broader open-source image analysis tools and keeps foreign or unassociated functionality to a

This project has been funded with support from the European Commission. This publication [communication] reflects the views only of the authors, and the Commission cannot be held responsible for any use which may be made of the information contained therein.

minimum. The architecture also emphasizes interaction and user-friendliness in most of the user-interface development efforts.

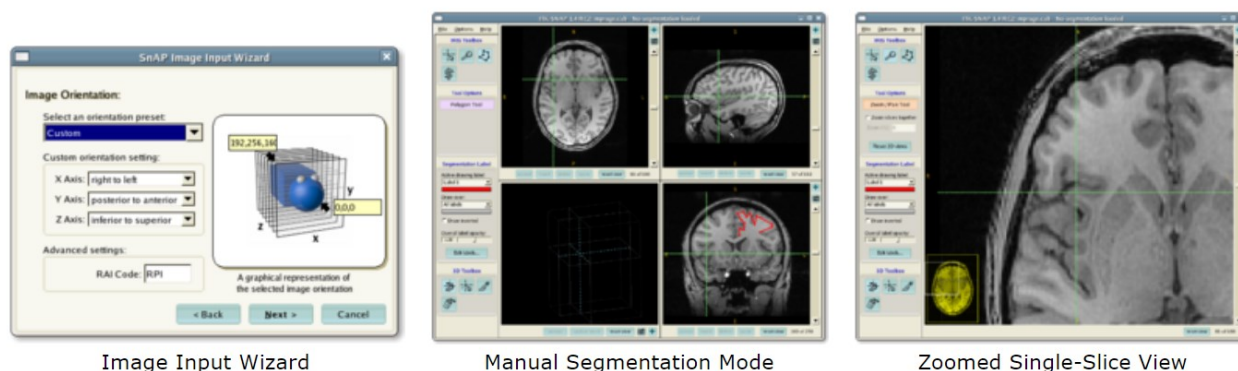

Figure 16. Some of the elements of the ITK Snap software (ITKSnap, 2021) Official webpages

Citation(s):(ITKSnap, 2021) Official webpages

2.3 3D Slicer

Official webpage(s):

<https://www.slicer.org/>

Description:

3D slicer is a free, open source and multi-platform program widely used in imaging and related disciplines, as well as for medical and biomedical purposes. Advanced image computing is addressed with an all-in-one software tool to provide diverse processing features along with a specificity for clinical and biomedical use.

Some of the benefits are:

- Using free and open-source tools, this development platform allows you to easily design and deploy custom solutions for research and commercial products.
- 3D ultrasound reconstruction in real time using the SlicerIGT and SlicerIGSIO extensions, a 3D volume is reconstructed from real-time tracked ultrasound.
- NVidia Clara is used for AI-assisted segmentation - using pre-trained models, use the NVidia AI-assisted annotation tool in Segment Editor to automatically segment anatomical structures.

This project has been funded with support from the European Commission. This publication [communication] reflects the views only of the authors, and the Commission cannot be held responsible for any use which may be made of the information contained therein.

- Interventions supported by robots - slicer is linked to a KUKA robot to display 3D models of the robot, its anatomy, and its workspace. Realised during the CARS 2014 event that was held in Fukuoka, Japan. The framework was created during the NA-MIC Summer Project Week.

A group of knowledgeable users and developers who collaborate to enhance medical computing.



Figure 17. 3D slicer in action (3DSlicer, 2021)

Citation(s):(3DSlicer, 2021) Official webpages

2.4 Ginkgo CADx

Official webpage(s):

<https://sourceforge.net/projects/gingocadx>

Description:

Ginkgo CADx is an expandable Open-Source Medical Imaging multi-platform that offers advanced technologies with a full DICOM Viewer solution.

This project has been funded with support from the European Commission. This publication [communication] reflects the views only of the authors, and the Commission cannot be held responsible for any use which may be made of the information contained therein.

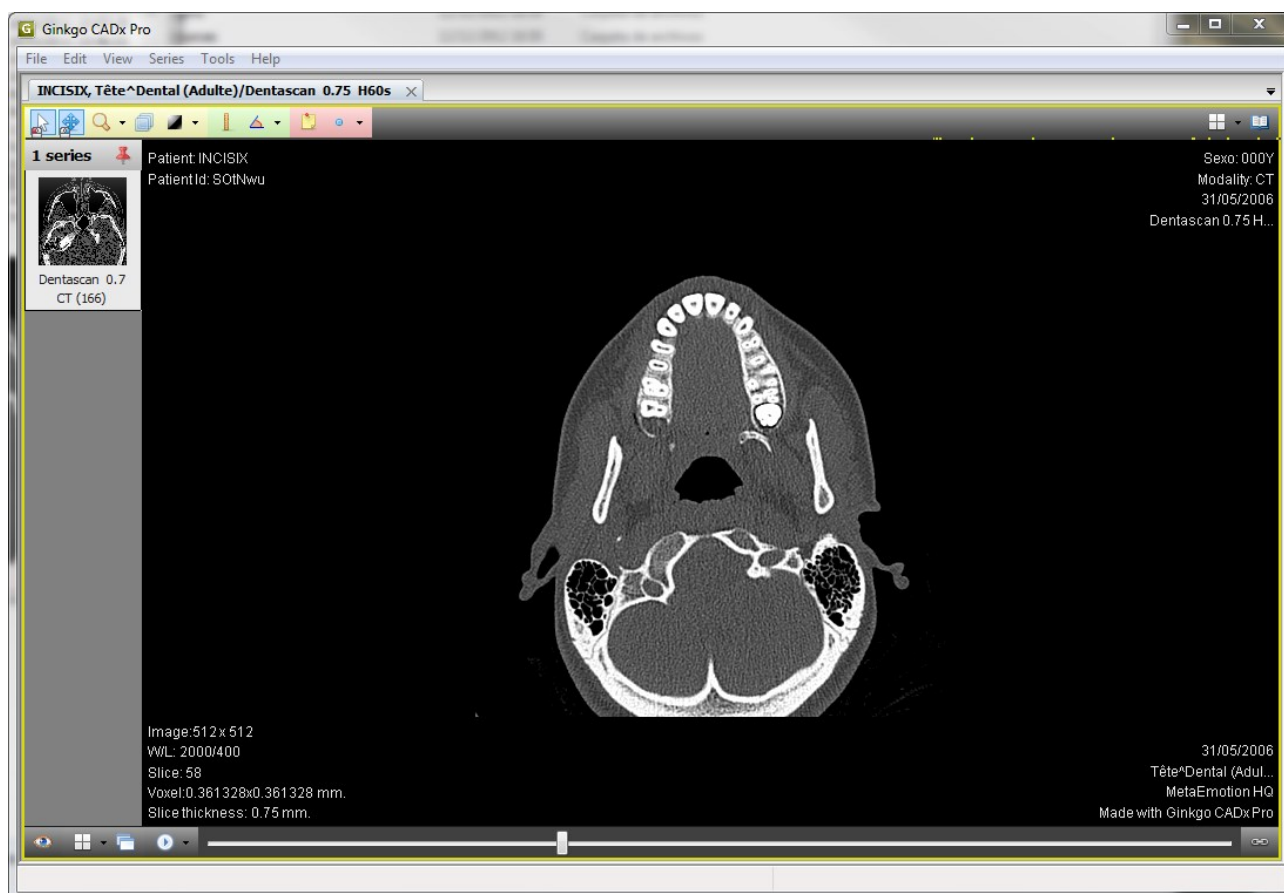

Figure 18. Ginkgo CADx main window (Ginkgo CADx, 2021)

Citation(s): (Ginkgo CADx, 2021) Official webpages

This project has been funded with support from the European Commission. This publication [communication] reflects the views only of the authors, and the Commission cannot be held responsible for any use which may be made of the information contained therein.

2.

This project has been funded with support from the European Commission. This publication [communication] reflects the views only of the authors, and the Commission cannot be held responsible for any use which may be made of the information contained therein.



B. M. PLAST d.o.o.

This project has been funded with support from the European Commission. This publication [communication] reflects the views only of the authors, and the Commission cannot be held responsible for any use which may be made of the information contained therein.



B. M. PLAST d.o.o.

3 Testing and controlling

3.1 Standardisation process

In the past, every part of a machine was designed and manufactured solely for the needs of that machine alone. It was quickly realized that it would be useful to achieve some kind of agreed reduction in the variety of shapes and dimensions of machine parts of the same purpose and functionality. This process is called standardization, and it facilitates the engineering process in such a way that it is not necessary to solve the same problems again and again. The application of standardization enables large-scale and economical production thanks to process automation and thus significantly affects the saving of time, materials, engineering, safety, etc.

The definition of standardization is the process of accepting and complying the regulations with the aim of meaningful organization in a particular area of human activity and achieving the greatest possible economy in meeting the requirements of functionality and safety. The standardization process is based on proven results of science, technology, and experience.

There are several forms of standards, and they differ in:

- Basic standard - covers a wide area and contains general provisions from a selected field.
- Terminological standard - includes expressions and definitions used for the purpose of explanation, illustration, etc.
- Test standard - includes test methods that supplement other provisions such as sampling, test scheduling and the use of statistical methods.
- Product standard - regulates the requirements that a product must meet to ensure its intended use.
- Process standard - regulates the requirements that must be met by the production process, in order to ensure its purpose.
- Calculation standard - prescribes the calculation procedure that must be carried out to ensure the functionality and operability of the machine part.
- Production standard - prescribes the requirements that must be met by production, to ensure its purpose.

The process of accepting standards begins with internal standardization at the factory. If such a standard is accepted in cooperation with related factories at the national level, the national standard is accepted. Today there are also international and global standards.

3.2 Standards and tolerances, dimension control

Due to the imperfection of several factors of the production process (machines, tools, materials, people etc.), it is not possible to achieve any dimension perfectly accurately. Absolute accuracy is not

This project has been funded with support from the European Commission. This publication [communication] reflects the views only of the authors, and the Commission cannot be held responsible for any use which may be made of the information contained therein.

possible, nor necessary for the correct operation of the machine or other components. It is therefore necessary to set the permissible deviations of each machine part. These deviations from absolute values are called tolerances. We can therefore say that tolerances are allowed deviations from the nominal measure.

Tolerances are divided into:

- Tolerances of length measures - that are subdivided in tolerances for external (eg. shaft and axle length) and internal (eg. hole diameter, wedge groove width, bore etc.) measures.

Table 1. Tolerances of length measures

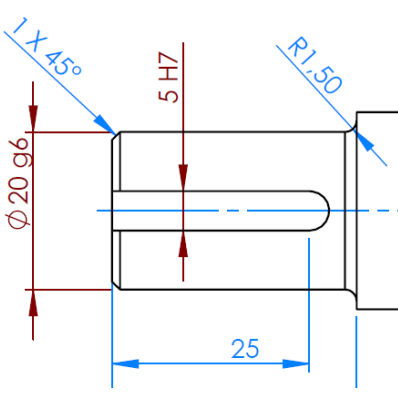
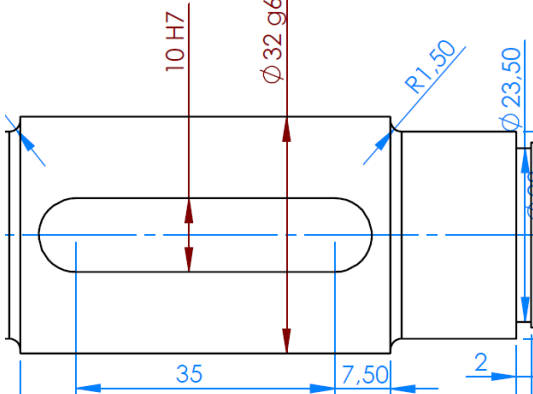
			
External tolerances with ISO system		Internal tolerances with ISO system	
Φ20 g6	-0,007	Φ32 g6	-0,009
	-0,020		-0,025
5 H7	+0,012	10 H7	+0,019
	0,000		0,000

In the ISO tolerance system, the letter indicates the beginning of the tolerance field, and the number indicates the width of the tolerance field. The capital letters are used for internal measures (eg H7) while the lower case letters are used for external measures (eg g6).

Table 2. Tolerances of length measures

Tolerances of length measures - quality of tolerance field																		
01	0	1	2	3	4	5	6	7	8	9	10	11	12	13	14	15	16	17

This project has been funded with support from the European Commission. This publication [communication] reflects the views only of the authors, and the Commission cannot be held responsible for any use which may be made of the information contained therein.

Precise tolerances for measuring instruments.																			
						Manufacturing process measuring instruments													
						Best quality manufacturing													
						Quality manufacturing													
						Medium quality													
						Rough quality													
						Semi-finished, forged and cast products													

- Shape and position tolerances - determines the geometry and assembly requirements of a part or components.
- Tolerances of surface roughness quality - defines the surface finish and it comprises the small, local deviations of a surface from the perfectly flat ideal object.

Another important component is indicated by limits and fits. They determine the relationship of two shaped elements (e.g., bore and shaft) that have the same nominal dimensions $D_i = d_i$ (one internal and the other one external). Both seating parts have their tolerances. Depending on the chosen tolerances of the two components we can have:

- Loose fit - there is always airiness between the assembled parts.
- Solid fit - there is a constant fold between the assembled parts. The fit can be achieved by heating the part with the inner measure and cooling the part with the outer measure.
- Transitional fit - gaps and overlaps can occur between parts.

This project has been funded with support from the European Commission. This publication [communication] reflects the views only of the authors, and the Commission cannot be held responsible for any use which may be made of the information contained therein.

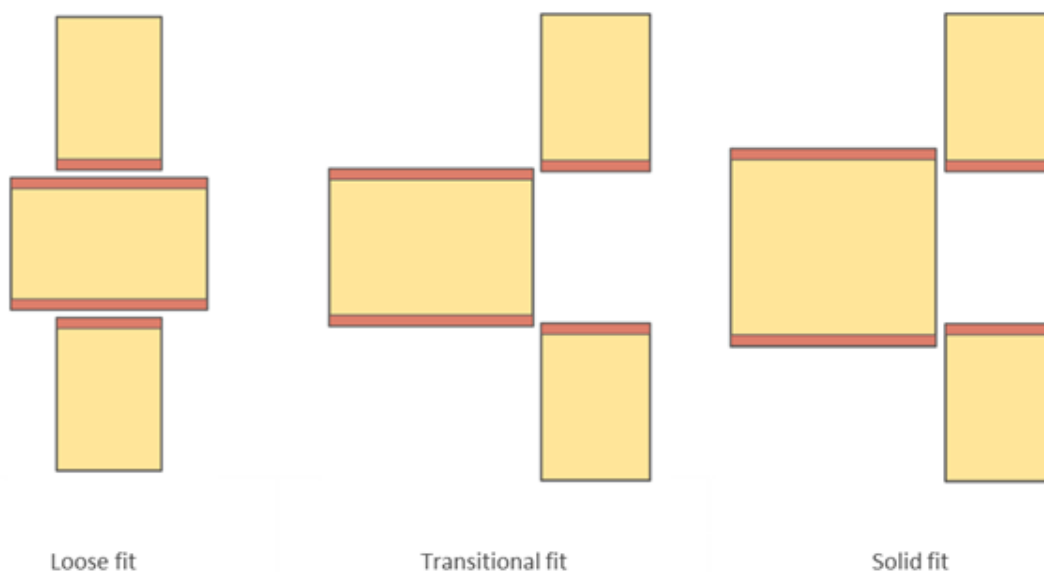

Figure 19. Components fits

According to the ISO system, there are two basic fitting systems:

1. Single bore system: all bore diameters have a tolerance field of “H”, regardless of the type of fit. The shaft tolerance is selected according to the desired fit depending on the bore.
2. Single axle system: all axle diameters have a tolerance field of “h” for the position, regardless of the type of fit. The bore tolerance is selected according to the desired fit depending on the shaft.

In general, a single hole system is used more often, as shaft measurements are easier and more accurate to make.

This project has been funded with support from the European Commission. This publication [communication] reflects the views only of the authors, and the Commission cannot be held responsible for any use which may be made of the information contained therein.

Table 3. Components fits

Type of fit	Single bore system:			Fit characteristics
	Priority groups			
	1.	2.	3.	
Loose fit	/	H11/a11 H11/c11 H9/c11 H8/d9 H8/e8	H11/b11 H8/b9 H8/c9 H9/d10 H9/e9	High clearance, guaranteed mobility.
	H7/f7 H8/f8	/	H7/f6 H9/f8	Medium clearance, easy mobility.
	/	H7/g6	H6/g5	Low clearance, mobility possible.
	H11/h9 H9/h9 H8/h9 H8/h8 H7/h6	H11/h11 H9/h11	H13/h13 H12/h12 H9/h8 H6/h5	Very low clearance, hand mobility possible on lubricated surfaces.
Transition fit	/	H7/j6 H6/j6	H6/j5	Very low clearance and folding, hand mobility possible with small shocks and hits.
	/	H7/k6 H6/h6	H6/h5	Very low clearance and folding, mobility with small shocks and hits.
	H7/n6	/	H7/m6 H6/m5	Very low clearance and folding, mobility with small shocks and hits.
Solid fit	H7/r6	/	H6/n5 H6/p5 H7/p6 H6/r5	Significant folding, retraction possible only by press or heating / cooling system.

This project has been funded with support from the European Commission. This publication [communication] reflects the views only of the authors, and the Commission cannot be held responsible for any use which may be made of the information contained therein.

	/	H7/s6	H6/s5 H7/t6 H6/t5	Significant folding, retraction possible only by press or heating / cooling system.
	H8/u8	H8/x8	H6/n5 H7/u6 H7/x6 H7/z6	Very large fold, retraction possible only by press or heating / cooling system.

This project has been funded with support from the European Commission. This publication [communication] reflects the views only of the authors, and the Commission cannot be held responsible for any use which may be made of the information contained therein.

This project has been funded with support from the European Commission. This publication [communication] reflects the views only of the authors, and the Commission cannot be held responsible for any use which may be made of the information contained therein.



B. M. PLAST d.o.o.

4 Measurements

Taking component measurements is critical in every manufacturing and assembly process. Most measurements are usually being taken from components that have been manufactured using traditional subtracting technologies, but as additive technologies are evolving and being used more and more often in the creation of functional prototypes, a need arose of taking measurements and to create a tolerance scheme for additive manufacturing components (Leach, Bourell, Carmignato, Donmer, Senin, and Dewulf, 2019).

Measurements of components can be taken for different reasons that are applicable to components manufactured by both subtractal and additive technologies. Some of these reasons are the following (Leach, Bourell, Carmignato, Donmer, Senin, and Dewulf, 2019):

- is the part fit for the purpose (for example, will a shaft fit through a hole while still giving enough clearance to allow the flow of lubricating fluids).
- making sure that assembly of complex components is possible.
- controlling of a manufacturing process.
- avoiding unnecessary scrap materials as well as redundant processing time.
- improving energy efficiency.
- give the customer confidence in the product.

4.1 Geometrical metrology

Additive manufacturing technologies allow almost infinite design freedom when designing components that will be created with additive manufacturing. When designing components that will be produced using comun subtractive manufacturing technologies, we need to consider when designing these components also the manufacturing methods. In subtractive manufacturing technologies there are a lot of geometrical constraints that need to be considered. From the metrology point of view, designing with unlimited freedom results in more complex geometries to be measured. Additive manufacturing technologies are still in the early stages of development, and therefore there are still areas on which it can be improved. AM components created from metal powder are commonly characterized by high surface roughness. It still is not clear how to apply dimensional tolerance schemes to components made with AM technologies.

4.2 CAD metrology

This project has been funded with support from the European Commission. This publication [communication] reflects the views only of the authors, and the Commission cannot be held responsible for any use which may be made of the information contained therein.

Creating a CAD model is a necessary step when we want to manufacture a part using additive manufacturing. CAD models must be converted in STL files, that is a file compatible for slicing software used to set different 3D printing parameters with the scope of creating the G-code on which the 3D printer will run the manufacturing process of the desired component. There are different ways on how a CAD model can be created such as creating the model from scratch, uploading a model that was found online, or by scanning a model, and using that scan to create a virtual 3D model. When scanning the model, we don't need to know all the different dimensions and geometries of the component we are scanning. But if we want to check and inspect the real model with the CAD model that was made by 3D scanning, then there are different tools we can use. If using Autodesk FUSION 360, we have a tool that is intended for that purpose, and it can be found in the tool palette, under the field Inspect, and the command is called Measure.

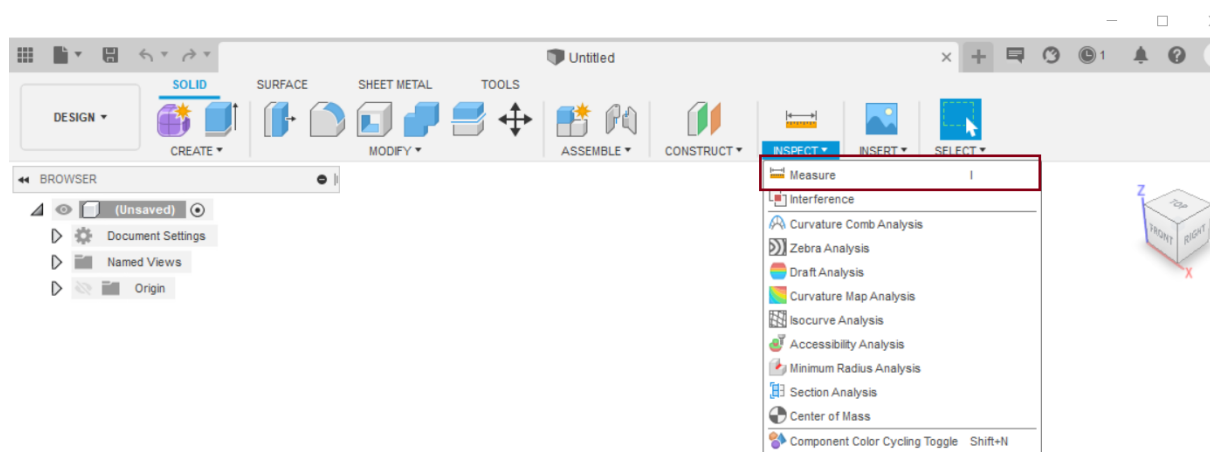

Figure 20. Fusion 360 : measure

This command can be used to measure hole diameter, distances, angles, areas or position date of the desired object. We can access all of this data by selecting the desired vertex, edge, face, body or component.

This project has been funded with support from the European Commission. This publication [communication] reflects the views only of the authors, and the Commission cannot be held responsible for any use which may be made of the information contained therein.

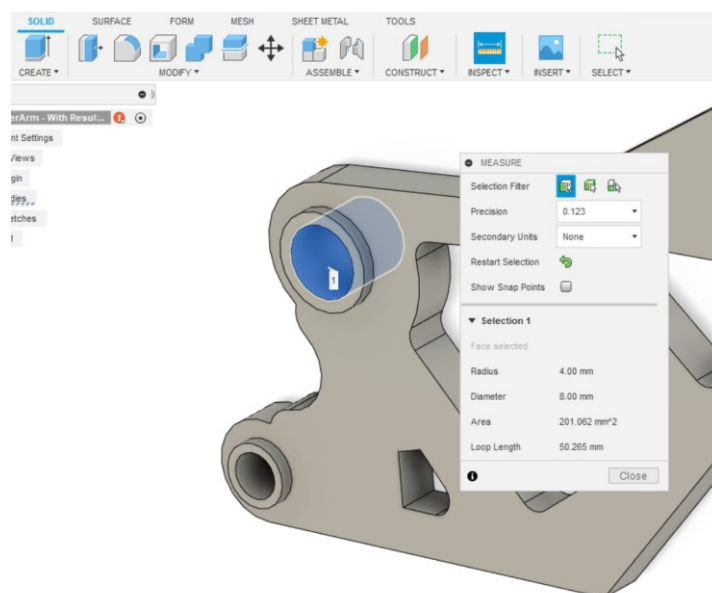

Figure 21. Measuring hole diameter in FUSION 360

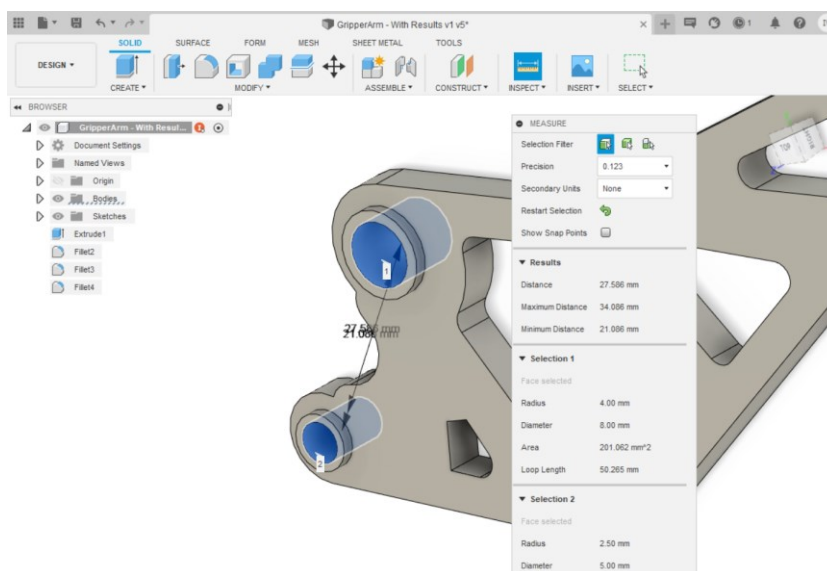

Figure 22. Measuring the distance between two holes in FUSION 360

This project has been funded with support from the European Commission. This publication [communication] reflects the views only of the authors, and the Commission cannot be held responsible for any use which may be made of the information contained therein.

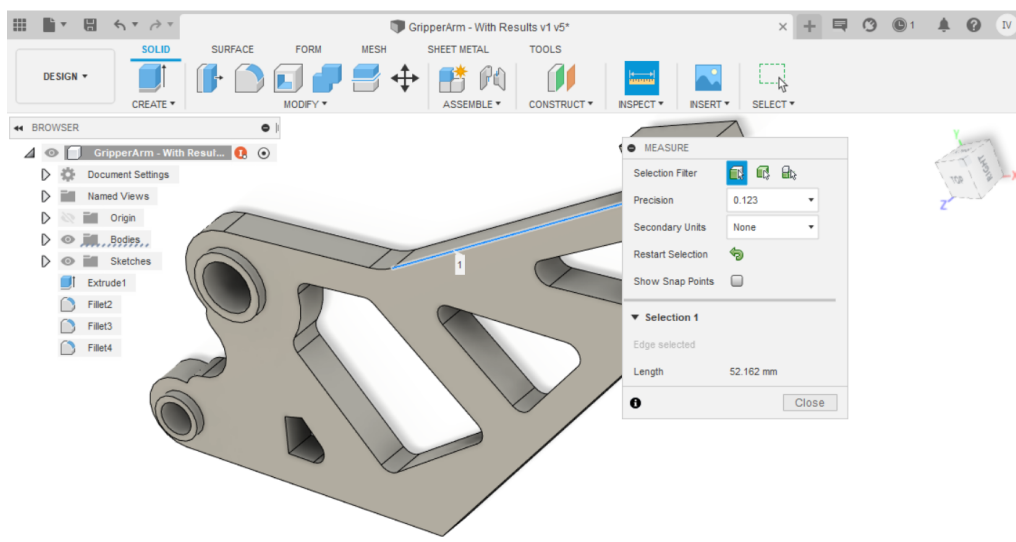

Figure 23. Measuring the length of an edge in FUSION 360

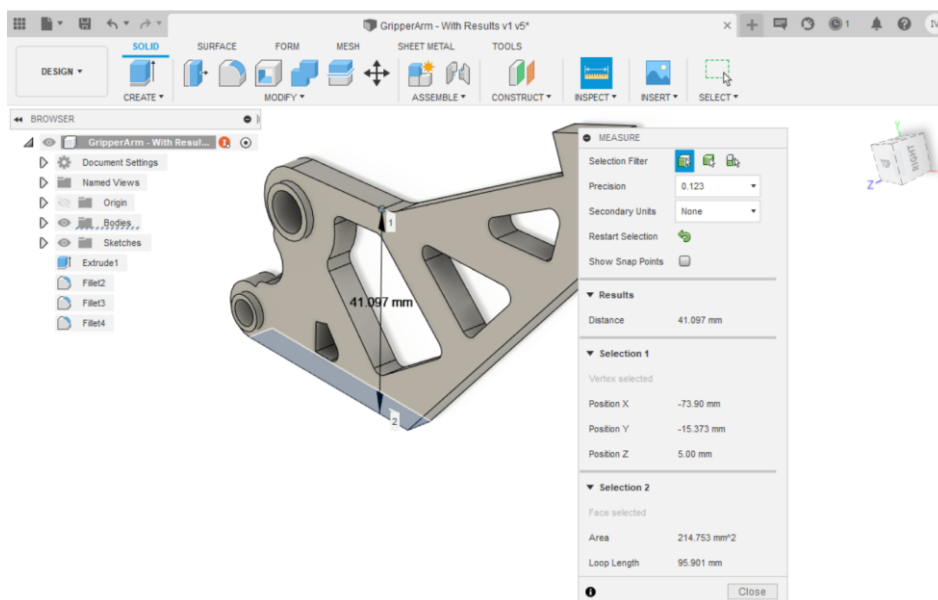

Figure 24. Measuring the the distance between a face and a point/edge/face in FUSION 360

This project has been funded with support from the European Commission. This publication [communication] reflects the views only of the authors, and the Commission cannot be held responsible for any use which may be made of the information contained therein.

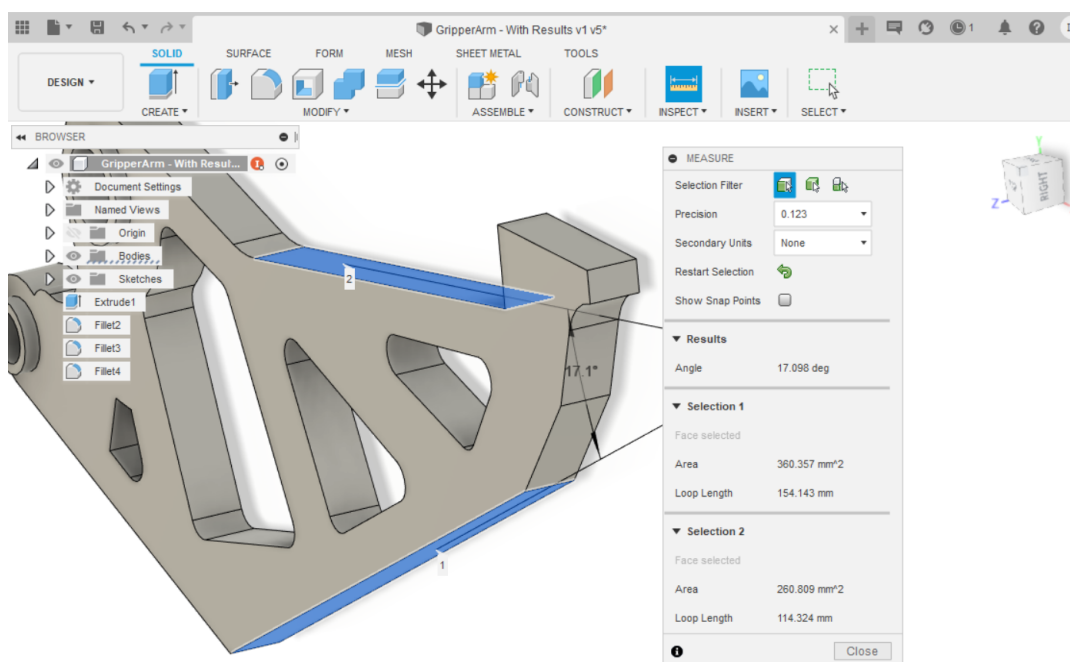

Figure 25. Measuring the angle between two faces in FUSION 360

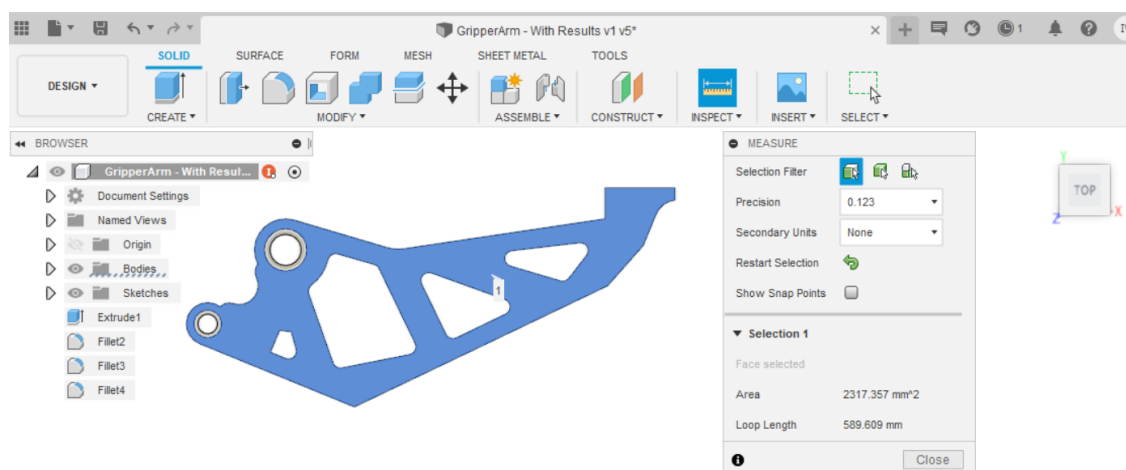

Figure 26. Measuring the area in FUSION 360

4.3 CMM - coordinate measuring machine

Coordinate measuring device is a measuring instrument used for spatial measurement of complex bodies (shape, length, angles, mutual position of surfaces and holes). Coordinate measuring machines (CMM) are used to obtain three-dimensional methodological form information on a workpiece and to estimate it. Coordinate measuring machines can measure the coordinates with a submicrometer of spiral points on the surfaces of samples. CMMs are the most common measuring systems used to assess the conformity of manufactured components with their geometric specifications (Harmatys, Marxer, Gaska, Gruza and Gaška, 2020). Optical CMMs are currently gaining popularity because they

This project has been funded with support from the European Commission. This publication [communication] reflects the views only of the authors, and the Commission cannot be held responsible for any use which may be made of the information contained therein.

allow fast and contactless measurement with accuracy almost the same as in the case of tactile measurements. During the measurement, the points at which the measurement is performed are usually not exactly at the intended location, but due to various influences they are in the area surrounding this location (Harmatys, Marxer, Gaska, Gruza and Gąska, 2020).

The uncertainty of Coordinate measuring machines is mainly affected by accuracy of the sensitivity of probe and moving parts such as lead bolts and guides (Park, Kwon and Cho, 2006). The requirements for faster measuring speeds to deal with high throughput, increased floor robustness and reduced machine prices are at odds with the basic precision requirement. At a higher level, modern surface metrology concepts based on multi-sensor and multi-scale techniques are a step in the right direction (Ringkowski, Sawodny, Hartlieb, Haist and Osten, 2020).

Figure 27. shows a Coordinate measuring device. Model of the Coordinate measuring device is Spectra, Operation is CNC, Measuring Range is X 600mm, Y 1000mm & Z 500mm, Operating System – CAD Comparison, Graphical Presentation.

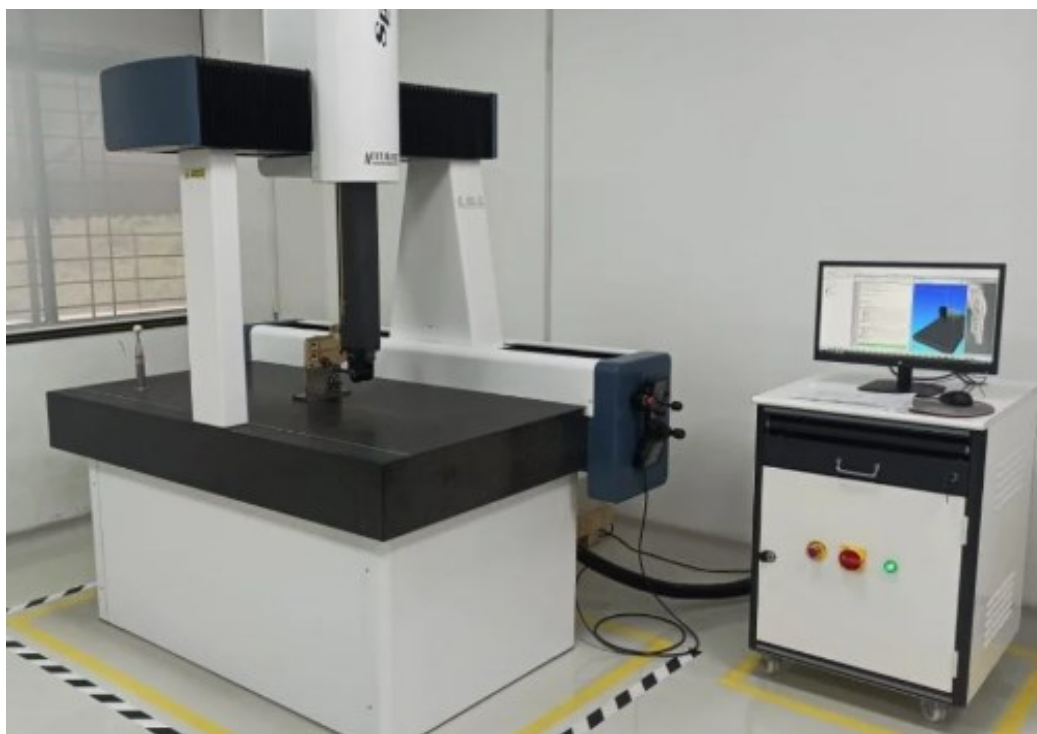

Figure 27. Coordinate Measuring Machine

From: Ampco Metal (2021). <https://www.ampcometal.com/what-is-a-coordinate-measuring-machine/>

The parts to be measured are securely placed on a solid table, usually made of granite, which is ground. The probes, which come in different sizes and types, are placed on the pen with a pen and that pen is connected to a portal that moves in the X-Y-Z coordinate plane. The probe and stylus are rotating

This project has been funded with support from the European Commission. This publication [communication] reflects the views only of the authors, and the Commission cannot be held responsible for any use which may be made of the information contained therein.

independently to access different part features. All the motions of probe and gantry can be controlled manually (Ampco Metal, 2021). The probe and stylus are connected to excellently sensitive electronics that detects even the smallest deviations in the electrical resistance coming from the probe (Ampco Metal, 2021). Figure 28. shows a probe of CMM.



Figure 28. Probe of CMM

From: Ampco Metal (2021). <https://www.ampcometal.com/what-is-a-coordinate-measuring-machine/>

4.4 3D scanning

3D scanning process is the analysis of an object or environment from the real world in order to collect data on its appearance and shape. The collected data can be used to create digital 3D models. In other words, 3D scanning is technology capable of creating high-precision 3D models of real- world objects. 3D scanning technology in the following way: The 3D scanner captures multiple images of the object. The images are then merged into a 3D model, an exact three-dimensional copy of the object. The object can be rotated and viewed from different angles on the computer (Kivolya, 2019). Unlike 2D photos made up of pixels, 3D scanning consists of tiny triangles or polygons. Polygons form a polygonal grid that repeats the geometry of an object in the smallest detail. A 3D scanner works similarly like a camera, meaning it takes shots of objects. However, the camera makes two-dimensional stills, while the scanner captures the geometry of the object's surface, and shots it has made are

This project has been funded with support from the European Commission. This publication [communication] reflects the views only of the authors, and the Commission cannot be held responsible for any use which may be made of the information contained therein.

worked into a 3D model rather than a picture or video (Kivolya, 2019). 3D scanning has many applications. Some of the more popular applications are:

- Industrial design and engineering,
- Medical industry
- Forensics
- Archeology and heritage preservation
- Design and art

The healthcare industry has benefited greatly from the integration of 3D scanning. 3D scanning is used for research, patient care, and the creation of personalized medical solutions. The main advantages of this technology are speed, precision, and safety of various stationary and portable 3D scanners, which is very important. With the help of 3D scanner healthcare practitioners can now effortlessly and quickly perform a full body scan. Physicians can then work with scan data to conduct research and monitor changes in body measurements that occur over time. 3D scanning has greatly simplified obtaining and comparing accurate patient data (Kivolya, 2019). Figure 29. shows a clinical nurse who is using the Artec Spider to scan a patient ear. The Royal Hospital for Sick Children has successfully turned 3D technology to treat children with microtia (Newmarker, 2017).

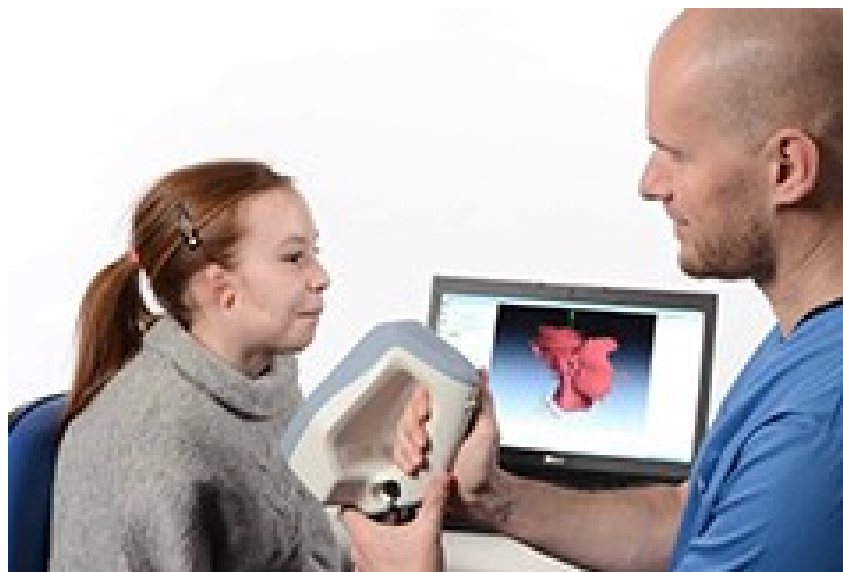

Figure 29. 3D technology that treats children with microtia (*abnormal smallness of the ear*)

From: Newmarker (2017).

<https://www.medicaldesignandoutsourcing.com/3d-technology-personalized-healthcare/>

4.5 Photogrammetry

This project has been funded with support from the European Commission. This publication [communication] reflects the views only of the authors, and the Commission cannot be held responsible for any use which may be made of the information contained therein.

Photogrammetry is a method used to create 3D models. This technology uses photographs to gather data, instead of using active light sources. Photogrammetry only requires a camera, a computer and specialized software, unlike 3D scanning which requires expensive machines (Photodeler, 2020). To create a 3D model using photogrammetry, photographs are taken from different angles to capture each part of the object with overlap from image to image. This overlap is required for the software to align the photos properly. Once all the images have been taken, they will be imported into the photogrammetry software, which aligns the images, draws the data points, and calculates the distance and location of each point in the 3D space. The result is a 3D point cloud that can create a polygonal grid, just like a 3D scan (Photodeler, 2020). Photogrammetry is a science and technology that allows the determination of quantitative properties. Reproduction of shapes, sizes and positions of objects based on their photographs. Images can be recorded in a wide format of the wavelength range of electromagnetic radiation. The most common is the visible range, but near and medium infrared, thermal infrared, microwave ovens and X-rays are also used (Ey-Chmielewska, Chruściel-Nogalska and Chruściel-Nogalska, 2015).

4.5.1 Medical Applications of Photogrammetry

In medicine, photogrammetry is applied as a method of reproducible reproduction of the body structure to plan and monitor therapeutic treatment and its results. Photogrammetric methods are currently used most in orthopedics. They enable fast measurements of the whole body or parts of it, for example in screening tests of spinal curvature (Ey-Chmielewska, Chruściel-Nogalska and Chruściel-Nogalska, 2015).

Human body measurement for the purpose of medical rehabilitation

The photogrammetric methods are very convenient and precise tools for measuring biological forms and functions, as well as shapes, locations and three-dimensional dimensions of anatomic structures and their movements and changes in time. Measurements can be applied to the body surface, sub-surface elements and body interior (x-raying, magnetic resonance). While being easy and cheap, the method of using photo cameras required, however, negative processing and photograph measurement by means of specialised, photogrammetry equipment which considerably delayed obtained almost immediately what allows for proper rehabilitation intervention activities to be performed (Tokarczyk and Mikrut, 2000).

Measurement system for the purpose of medical rehabilitation should enable the following (Tokarczyk and Mikrut, 2000):

- non-contact nature of measurement

This project has been funded with support from the European Commission. This publication [communication] reflects the views only of the authors, and the Commission cannot be held responsible for any use which may be made of the information contained therein.

- minimum level of patient troubling which means conducting measurements in the clinic and as quickly as possible
- analytical and graphical result interpretation
- system cost minimization
- determination of body point locations and relations between them in a three-dimensional space

4.6 Dimension control - with Artificial Intelligence

Dimensional analysis is a modeling technique that uses knowledge from the domain in the form of physical dimensions of model parameters. Dimensional analysis is based on the principle of dimensional homogeneity, the physical dimension data of the model parameters are used to reduce the combinatorial complexity in the search for the correct model (Rudolph, 1998). Human body measurements are used to assess health trends in various populations.

Lokshin, Sajaia and Azari, (2018). used machine learning to measure a person's height from a picture. They concluded that with the iteratively purified method, it is possible to obtain a measure of one's height with an accuracy of up to 1% from a well-composed image with a calibrated print of the paper. They achieved good accuracy in measuring human height in photographs taken with the tablet's built-in camera. They managed to calculate a person's height by comparing the dimensions (in pixels) of an object of known size with the dimensions of the human body (Figure 30).

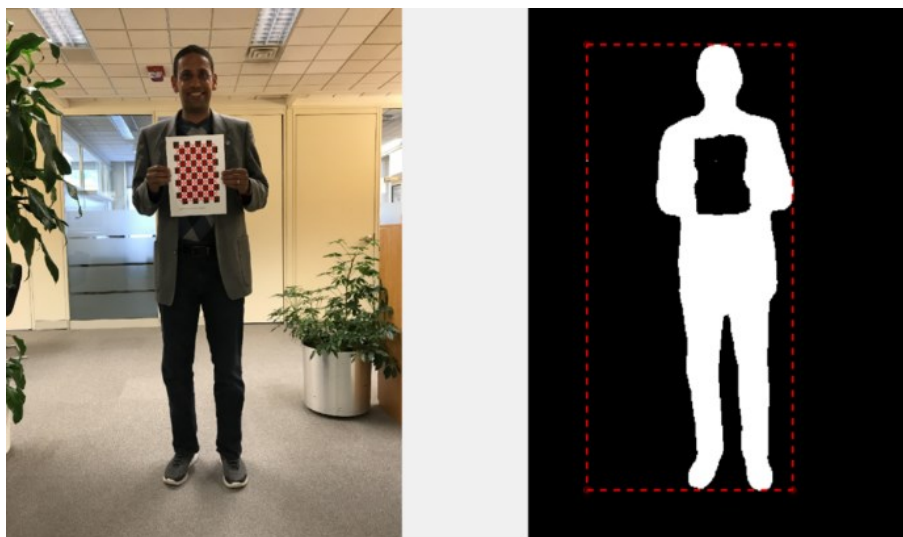

Figure 30. Respondent holding a sample image. The red lines on the chessboard are covered by the ML algorithm that recognizes the angles of the squares.

From: Lokshin, Sajaia and Azari (2018).

This project has been funded with support from the European Commission. This publication [communication] reflects the views only of the authors, and the Commission cannot be held responsible for any use which may be made of the information contained therein.

This project has been funded with support from the European Commission. This publication [communication] reflects the views only of the authors, and the Commission cannot be held responsible for any use which may be made of the information contained therein.



B. M. PLAST d.o.o.

5 Preparation for testing in the clinical environment

5.1 Implementation of Artificial Intelligence

Reim, Åström and Eriksson (2020). suggest four steps when implementing Artificial intelligence (Figure 31). When using AI as a catalyst for digital transformation through the Innovation Business model (BM), companies must develop specific capabilities and reach a certain level of maturity. These capabilities are described as strategic, technological, data, and security capabilities. Theoretical remarks regarding AI as a catalyst for BMI (Business model innovation) resulted in four key insights. Theoretical concepts relate to research in AI, BMI, digital transformation, and business ecosystems.

Consequently, key acquisitions are defined as the need to (Reim, Åström and Eriksson, 2020):

1. **Understand AI and organizational skills required for digital transformation-** Understanding the characteristics of artificial intelligence will lay the foundations for future implementation plans. This initial step will primarily involve top management as the purpose is to develop a conceptual framework for the use of artificial intelligence and for assessing a company's capabilities.
2. **Understand the current Business model, and potential for business model innovation and the role of the business ecosystem -** Before starting a business model innovation, it is important to understand how value is currently being created, recorded, and delivered. How is technology used to improve supply and exceed customer expectations? Technical uncertainty stems from technological maturity and understanding of technology, but it also depends on the external market.
3. **Develop and improve the skills required to apply AI-** The introduction of Artificial intelligence will often require significant transformations of core business operations and capabilities, causing uncertainty and risk. Companies may choose to take two different strategies when transforming a company - the role of the first programmer or the first follower. For inspiration can be carried out activities marking the bench and evaluation of surrounding businesses develop both technical and strategic solutions.
4. **Achieve organizational acceptance and develop internal competencies-** Digital transformations often face risks associated with organizational resistance when implementing artificial intelligence applications. This emphasizes the importance of achieving organizational acceptance during the implementation phase. Companies are quite dependent on the external environment, including cooperating companies or stakeholders in the environment. Therefore,

This project has been funded with support from the European Commission. This publication [communication] reflects the views only of the authors, and the Commission cannot be held responsible for any use which may be made of the information contained therein.

companies should seek to strengthen cooperation with partners understanding the application of artificial intelligence among affected parties.

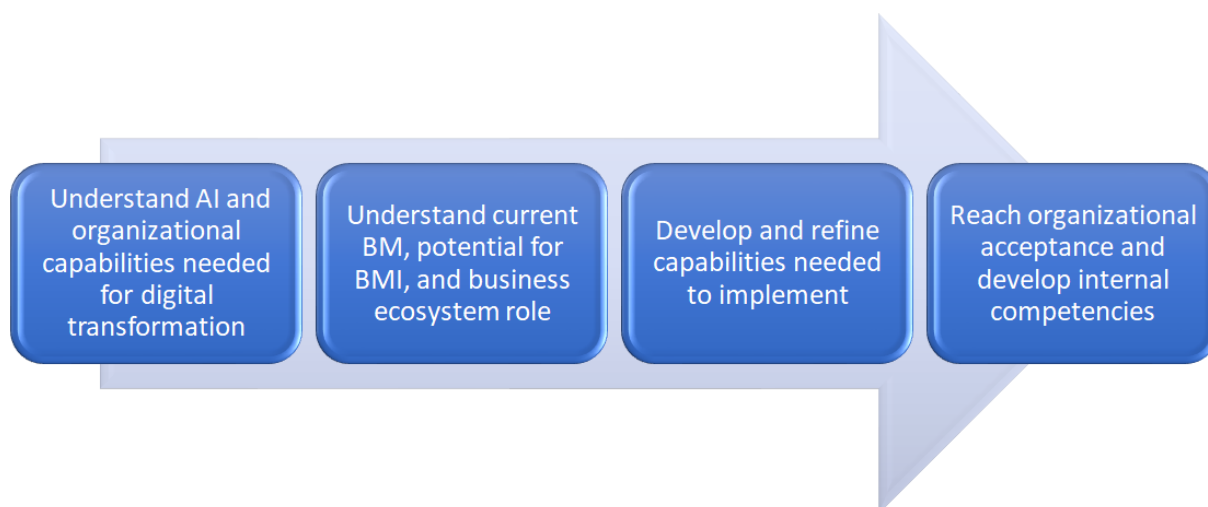

Figure 31. AI business model implementation

Adapted from: Reim, Åström and Eriksson (2020).

5.1.1 Key implementation issues of AI in medical field

Implementation of AI requires the availability of large amounts of data, integration in the complex existing clinical workflow and compliance with regulatory frameworks (He, L. Baxter, Xu, Xu, Zhou and Zhang, 2019).

This project has been funded with support from the European Commission. This publication [communication] reflects the views only of the authors, and the Commission cannot be held responsible for any use which may be made of the information contained therein.

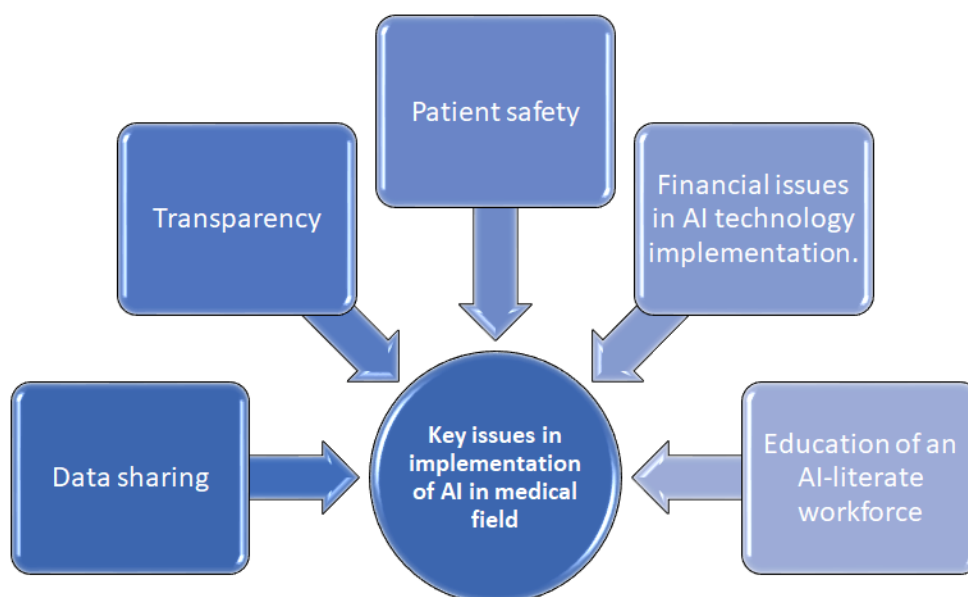

Figure 32. Key implementation issues of AI in medical field

Adapted from: He, L. Baxter, Xu, Xu, Zhou, and Zhang (2019).

1. **Data sharing-** A continuous supply of data is required for continuous training, validation, and improvement of AI algorithms. Data may need to be shared between multiple institutions and potentially between states. The data should be anonymous, informed consent procedures should include the possibility of wide distribution. Cyber security measures, increasingly important to address the risk of inappropriate use of datasets, lead to inaccurate or inappropriate detection and limitations in identification techniques (He, L. Baxter, Xu, Xu, Zhou, and Zhang, 2019).
2. **Transparency.** Data transparency and artificial intelligence algorithms are also main concerns. Transparency is important on several levels. First, in the case of supervised learning, the accuracy of prediction relies heavily on the accuracy of the underlying notes entered into the algorithm. Poor data indicates it will bring bad results. The transparency of labeling such that others can critically assess the process of training for supervised learning algorithms is the most important for ensuring accuracy (He, L. Baxter, Xu, Xu, Zhou, and Zhang, 2019). In addition to labeling issues, transparency also applies for interpretability modeling - in other words, people should be able to understand or interpret how a particular technology has reached a particular decision or prediction. The rationale of the system should be explained, then people can check if the rationale is correct (He, L. Baxter, Xu, Xu, Zhou, and Zhang, 2019).

This project has been funded with support from the European Commission. This publication [communication] reflects the views only of the authors, and the Commission cannot be held responsible for any use which may be made of the information contained therein.

3. **Patient safety** - Artificial intelligence systems face security challenges informed by complex environments, periods of learning during which system behavior can be unpredictable, and uncertainty human-machine interactions, which can result in significant variations in system performance. The next issue related to patient safety is the issue of accountability. If a patient suffers from an adverse event due to AI-based technology, who is responsible? AI technologies will undoubtedly change the traditional doctor-patient relationship (He, L. Baxter, Xu, Xu, Zhou and Zhang, 2019).
4. **Financial issues in Artificial intelligence technology implementation** - Funding will be crucial to ensure the successful implementation and continuous improvement of AI technology. For optimal performance, the AI system needs continuous maintenance, not only due to the inclusion of increasing amounts of data about the patient, but also in terms of updating software algorithms and ensuring operability of hardware (He, L. Baxter, Xu, Xu, Zhou and Zhang, 2019).
5. **Education of an artificial intelligence literate workforce** - All stakeholders should be actively involved in the process of applying AI in medicine. The workforce should be educated about Artificial intelligence and understand both its limitations and benefits. In an ideal world, physicians should understand the construction of algorithms, they would understand data sets which are the foundation of their results and, and understand their limitations. But in a world of limited resources, it will not be reasonable to expect every physician to reach that level of understanding (He, L. Baxter, Xu, Xu, Zhou and Zhang, 2019).

This project has been funded with support from the European Commission. This publication [communication] reflects the views only of the authors, and the Commission cannot be held responsible for any use which may be made of the information contained therein.



B. M. PLAST d.o.o.

This project has been funded with support from the European Commission. This publication [communication] reflects the views only of the authors, and the Commission cannot be held responsible for any use which may be made of the information contained therein.



B. M. PLAST d.o.o.

6 Virtual reality laboratory as a testing platform

Virtual reality (VR) enables us to experience and visualize different situations in a realistic simulation. Therefore, VR is often used in training, because it provides a safe, realistic and effective learning experience without it actually happening in real life. With virtual reality we can create any possible scenarios and simulations. The only limit is our imagination. We can use VR to present a new laboratory with test equipment. We can create and navigate through a unique facility with products that are yet to be realized. This enables students, teachers, engineers, investors, and anyone who is interested to visualize the design and functionality of new products and equipment. VR also allows engineers and designers to experiment easily with the look and build of new products before commissioning expensive prototypes. Today VR is used in many different industries, but for the most part is used in:

- Automotive industry
- Healthcare
- Retail
- Tourism
- Architecture
- Learning and development

The first thing to do when setting up a virtual reality laboratory is having adequate space. For VR experience to be as effective as possible, it is recommended to have at least 5 square meters of free space for the VR user and an additional 2-meter buffer zone for the safety of other people in the room. Choosing the right equipment is crucial because not all VR sets are created equally, and some can be a very costly investment. That is why we need to keep in mind the functionality and the user interaction when choosing the right equipment. If the primary goal is to create a low level of interactivity in the VR laboratory, where participants will just witness another environment and will have minimal or non-interaction with its surroundings, then lower quality equipment will be just as good. If, on the other hand, we want to create a laboratory environment in which the user can interact with various objects and equipment providing a complete training experience, then high-quality VR equipment should be an imperative. This will help us to maximize the benefits of our VR laboratory.

This project has been funded with support from the European Commission. This publication [communication] reflects the views only of the authors, and the Commission cannot be held responsible for any use which may be made of the information contained therein.

This project has been funded with support from the European Commission. This publication [communication] reflects the views only of the authors, and the Commission cannot be held responsible for any use which may be made of the information contained therein.



B. M. PLAST d.o.o.

7 *The Ethical guidance for medical simulation and devices*

7.1 *Medical Simulation*

Medical simulation is widely used as an integral part of medical education. The simulation begins with an important moral statement: We must do the best we can to protect patients as we train the next generation of clinicians and retrain current clinicians to keep up. As a powerful teaching tool, the simulation enables the practice of communication, decision-making, practical skills, and leadership, as well as evaluation that can be standardized and does not pose a risk to patients associated with a real clinical environment. The simulation provides a safe zone for students for practical skills and communication errors and for developing moral imagination, while respecting ethical principles.

Simulation-based medical education (SBME) is increasingly recommended as an educational strategy and to improve patient safety. SBME is mainly conducted in simulation centers (OSS), which range from publicly funded simulation centers in hospitals and universities to simulation centers that are separate facilities funded by sponsors and user payments. Some hospital wards also provide OSS as an internal training room (s) specifically set up for simulation training outside the clinical setting.

The simulation brings improvements in student education and instills more humanity in the relationship with patients. Every year, millions of people die or are seriously injured due to mistakes in health practice. Therefore, it is crucial to provide safe care and to minimize medical errors in clinical practice and provide rapid responses to changing health conditions. Training in a simulated context before direct communication with patients should be imperative. Simulation activities should ensure patient safety without the risk of harm to the patient during the learning process. Therefore, students would be allowed to perform medical procedures on real patients after acquiring knowledge and skills in different simulated clinical scenarios. The simulation scenario is crucial in preparing students and clinicians before the first actual patient experience, including collaboration through team training, interprofessional, critical thinking, and independent decision-making skills. The vital components in these scenarios are pre-briefing and briefing. Effective feedback and briefing after the simulation can provide an opportunity to learn about ethical gaps in knowledge.

Ethics and the use of simulations share a common obstacle to a lack of faculty resources. There is a clear difference between teaching clinical content and medical ethics. Ethical principles are based on many factors such as social sciences, medical sciences, religion, law, economics, culture, language and more. Many different ethical considerations are more difficult to teach than any medical issue. The simulation also provides a safe zone for students to make mistakes in communication. Moral

This project has been funded with support from the European Commission. This publication [communication] reflects the views only of the authors, and the Commission cannot be held responsible for any use which may be made of the information contained therein.



B. M. PLAST d.o.o.

imagination is necessary because it represents the ability to feel empathy towards others, thus making the right ethical decisions.

Oxford Medical Simulation provides medical and virtual reality medical simulation. This helps educators save time and money in delivering quality, flexible, measurable training that improves patient care. Oxford Medical Simulation offers scenario libraries inspired by true clinical situations and validated simulation sources. These scenarios put pressure on students in certain clinical situations, allowing them to make mistakes in a safe environment. Students can then think, review feedback, and repeat to ensure that they have succeeded for the first time in clinical practice (Oxford Medical Simulation, 2021). Figure 33. shows certain advantages of using VR simulation in the medical field.

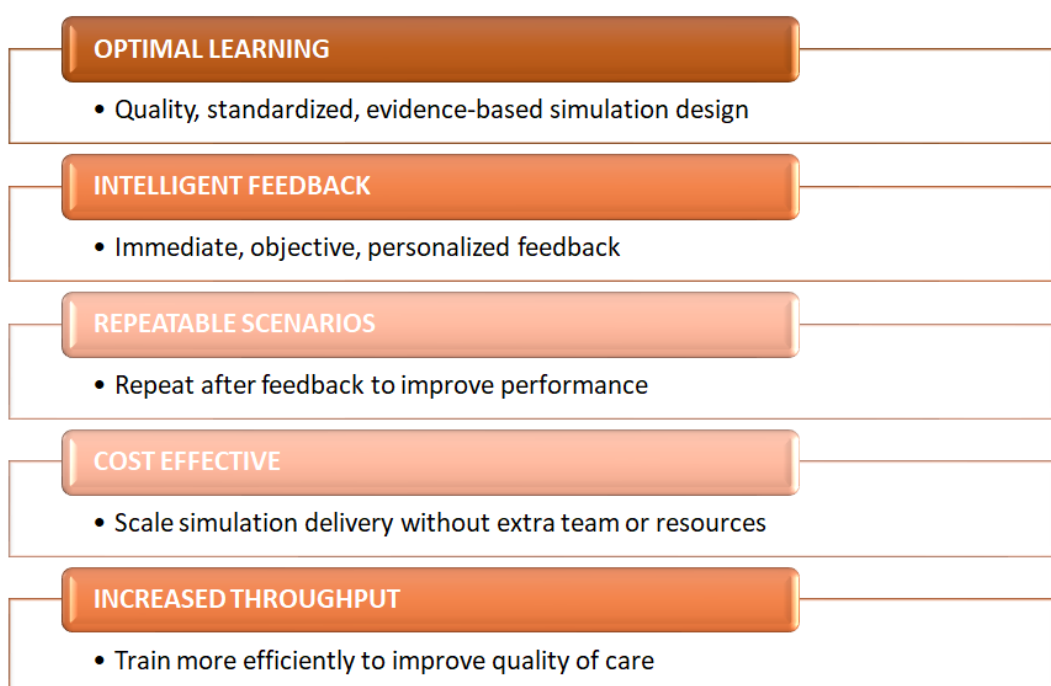

Figure 33. Benefits of VR simulation

Adapted from: Oxford Medical Simulation (<https://oxfordmedicalsimulation.com/>)

This project has been funded with support from the European Commission. This publication [communication] reflects the views only of the authors, and the Commission cannot be held responsible for any use which may be made of the information contained therein.

3.

This project has been funded with support from the European Commission. This publication [communication] reflects the views only of the authors, and the Commission cannot be held responsible for any use which may be made of the information contained therein.



B. M. PLAST d.o.o.

4.

This project has been funded with support from the European Commission. This publication [communication] reflects the views only of the authors, and the Commission cannot be held responsible for any use which may be made of the information contained therein.



B. M. PLAST d.o.o.

This project has been funded with support from the European Commission. This publication [communication] reflects the views only of the authors, and the Commission cannot be held responsible for any use which may be made of the information contained therein.



B. M. PLAST d.o.o.

6. References

1. Cho, Y. M., Kwon, S., Pak, Y. K., Seol, H. W., Choi, Y. M., Park, D. J., Park, K. S., & Lee, H. K. (2006). Dynamic changes in mitochondrial biogenesis and antioxidant enzymes during the spontaneous differentiation of human embryonic stem cells. *Biochemical and Biophysical Research Communications*, 348(4), 1472–1478. <https://doi.org/10.1016/j.bbrc.2006.08.020>
2. Ey-Chmielewska, H., Chruściel-Nogalska, M., & Frączak, B. (2015). Photogrammetry and Its Potential Application in Medical Science on the Basis of Selected Literature. *Advances in Clinical and Experimental Medicine*, 24(4), 737–741. <https://doi.org/10.17219/acem/58951>
3. Fernandes, F., Barbalho, I., Barros, D., Valentim, R., Teixeira, C., Henriques, J., Gil, P., & Dourado Júnior, M. (2021). Biomedical signals and machine learning in amyotrophic lateral sclerosis: a systematic review. *BioMedical Engineering OnLine*, 20(1). <https://doi.org/10.1186/s12938-021-00896-2>
4. Gaška, P., Gaška, A., & Gruza, M. (2017). Challenges for Modeling of Five-Axis Coordinate Measuring Systems. *Applied Sciences*, 7(8), 803. <https://doi.org/10.3390/app7080803>
5. Haleem, A., Javaid, M., & Khan, I. H. (2019). Current status and applications of Artificial Intelligence (AI) in medical field: An overview. *Current Medicine Research and Practice*, 9(6), 231–237. <https://doi.org/10.1016/j.cmrp.2019.11.005>
6. He, J., Baxter, S. L., Xu, J., Xu, J., Zhou, X., & Zhang, K. (2019). The practical implementation of artificial intelligence technologies in medicine. *Nature Medicine*, 25(1), 30–36. <https://doi.org/10.1038/s41591-018-0307-0>
7. Iqbal, S., Khan, M. U. G., Saba, T., & Rehman, A. (2017). Computer-assisted brain tumor type discrimination using magnetic resonance imaging features. *Biomedical Engineering Letters*, 8(1), 5–28. <https://doi.org/10.1007/s13534-017-0050-3>
8. Kohavi, R. and Provost, F. (1998). Glossary of terms. *Machine Learning—Special Issue on Applications of Machine Learning and the Knowledge Discovery Process*. *Machine Learning*, 30, 271-274. <https://doi.org/10.1023/A:1017181826899>
9. Kording Kp, Benjamin As, Farhoodi R, et al. (2018) The Roles of Machine Learning in Biomedical Science. In: National Academy of Engineering. *Frontiers of Engineering: Reports on Leading-Edge Engineering from the 2017 Symposium*. Washington (DC): National Academies Press (US); Available from: <https://www.ncbi.nlm.nih.gov/books/NBK481619/>
10. Kording, KP., Benjamin, AS., Farhoodi, R., et al. (2018). The Roles of Machine Learning in Biomedical Science. In: National Academy of Engineering. *Frontiers of Engineering: Reports on*

This project has been funded with support from the European Commission. This publication [communication] reflects the views only of the authors, and the Commission cannot be held responsible for any use which may be made of the information contained therein.

Leading-Edge Engineering from the 2017 Symposium. Washington (DC): National Academies Press, Available from: <https://www.ncbi.nlm.nih.gov/books/NBK481619/>

11. Lahmiri, S., Dawson, D. A., & Shmuel, A. (2017). Performance of machine learning methods in diagnosing Parkinson's disease based on dysphonia measures. *Biomedical Engineering Letters*, 8(1), 29–39. <https://doi.org/10.1007/s13534-017-0051-2>
12. Leach, R., Bourell, D., Carmignato, S., Donmez, A., Senin, N., & Dewulf, W. (2019). Geometrical metrology for metal additive manufacturing. *CIRP Annals*, 68(2), 677–700. <https://doi.org/10.1016/j.cirp.2019.05.004>
13. Lokshin, M. M., Sajaia, Z., & Azari, S. (2018, May 7). Survey specialists and data scientists meet: machine learning to measure a person's height from a picture. *World Bank Blogs*. <https://blogs.worldbank.org/opendata/survey-specialists-and-data-scientists-meet-machine-learning-measure-person-s-height-picture>
14. Lusted, L. B. (1955). Medical Electronics. *New England Journal of Medicine*, 252(14), 580–585. <https://doi.org/10.1056/nejm195504072521405>
15. Mangrulkar, A., Rane, S., & Sunnapwar, V. (2020). Image-based bio-cad modeling: overview, scope, and challenges. *Journal of Physics: Conference Series*, 1706, 012189. <https://doi.org/10.1088/1742-6596/1706/1/012189>
16. Park, C., Took, C. C., & Seong, J. K. (2018). Machine learning in biomedical engineering. *Biomedical Engineering Letters*, 8(1), 1–3. <https://doi.org/10.1007/s13534-018-0058-3>
17. Reim, W., Åström, J., & Eriksson, O. (2020). Implementation of Artificial Intelligence (AI): A Roadmap for Business Model Innovation. *AI*, 1(2), 180–191. <https://doi.org/10.3390/ai1020011>
18. Rudolph, S. (1998). On the Context of Dimensional Analysis in Artificial Intelligence.
19. Tokarczyk, R., & Mikrut, S., (2000). Close Range Photogrammetry System For Medicine And Railways, *International Archives of Photogrammetry and Remote Sensing*. Vol. XXXIII, Part B5. Amsterdam
20. Wang, L., & Yu, L. (2019). Introductory Chapter: Computer-Aided Diagnosis for Biomedical Applications. *Computer Architecture in Industrial, Biomechanical and Biomedical Engineering*. Published. <https://doi.org/10.5772/intechopen.88835>
21. Wierzbicki, J., Nowacki, M., Chrzanowska, M., Matkowski, R., Ziętek, M., Nowacka, K., Maciejczyk, A., & Pawlak-Adamska, E. (2020). Additive manufacturing technologies enabling rapid and interventional production of protective face shields and masks during the COVID-19

This project has been funded with support from the European Commission. This publication [communication] reflects the views only of the authors, and the Commission cannot be held responsible for any use which may be made of the information contained therein.



B. M. PLAST d.o.o.

pandemic. *Advances in Clinical and Experimental Medicine*, 29(9), 1021–1028.
<https://doi.org/10.17219/acem/126296>

Internet literature:

1. Helping in the COVID-19 Crisis. (2020). Maker Works. <https://www.maker-works.com/helping-in-the-covid-19-crisis#faceshields>
2. 3D printed face shields for medics and professionals. (2020, March 25). Prusa3D - 3D Printers from Josef Průša. <https://www.prusa3d.com/covid19/>
3. Maker Mask. (2020). <https://www.makermask.com/>
4. *Operation PPE*. (2020). Sabin Design Lab. <https://www.sabinlab.com/operation-ppe>
5. Ampco Metal (2021). <https://www.ampcometal.com/what-is-a-coordinate-measuring-machine/>
6. How to 3D scan an object | Tips from 3D scanning experts. (2019). Professional 3D Scanning Solutions | Artec3D. <https://www.artec3d.com/learning-center/how-3d-scan-object-portable-structured-light-scanner>
7. Newmarker, C. (2017, December 4). How 3D technology could usher in a new wave of personalized healthcare. *Medical Design and Outsourcing*.
<https://www.medicaldesignandoutsourcing.com/3d-technology-personalized-healthcare/>
8. combineLA. (2020, May 12). *Be Part of the Solution*. <https://combine.la/>
9. Oxford Medical Simulation. (2021, April 1). Oxford Medical Simulation - Virtual Reality Healthcare Training. <https://oxfordmedicalsimulation.com/>

Official pages:

1. (InVesalius, 2021) Official webpages
2. (ITKSnap, 2021) Official webpages
3. (3DSlicer, 2021) Official webpages
4. (Ginkgo CADx, 2021) Official webpages

This project has been funded with support from the European Commission. This publication [communication] reflects the views only of the authors, and the Commission cannot be held responsible for any use which may be made of the information contained therein.



B. M. PLAST d.o.o.